

The impact of exercise on the physiological alterations of SCUBA diving : investigations beyond venous gas bubbles

Madden, Dennis

Doctoral thesis / Disertacija

2014

Degree Grantor / Ustanova koja je dodijelila akademski / stručni stupanj: **University of Split, School of Medicine / Sveučilište u Splitu, Medicinski fakultet**

Permanent link / Trajna poveznica: <https://um.nsk.hr/um:nbn:hr:171:657879>

Rights / Prava: [In copyright](#)/[Zaštićeno autorskim pravom.](#)

Download date / Datum preuzimanja: **2024-11-30**



Repository / Repozitorij:

[MEFST Repository](#)



UNIVERSITY OF SPLIT SCHOOL OF MEDICINE

Dennis Madden

THE IMPACT OF EXERCISE ON THE PHYSIOLOGICAL ALTERATIONS OF SCUBA DIVING:
INVESTIGATIONS BEYOND VENOUS GAS BUBBLES

Doctoral Dissertation

Split, Croatia 2014

SVEUČILIŠTE U SPLITU MEDICINSKI FAKULTET

Dennis Madden

UTJECAJ TJELOVJEŽBE NA FIZIOLOŠKE PROMJENE KOD SCUBA RONJENJA:
ISTRAŽIVANJA IZVAN OKVIRA VENSКИH PLINSКИH MJEHURIĆA

Doktorska Disertacija

Split 2014

Acknowledgements

It has been an honor and a privilege to work with, learn from, and be a part of the Department of Integrative Physiology at the University of Split School of Medicine over the past three years.

First I would like to thank my committee, Assistant Professor Vladimir Ivančev, Professor Mladen Boban, and Professor Stjepan Gamulin, for their guidance and patience.

Next I would like to thank my mentor Professor Zeljko Dujic for allowing me the freedom to make my own way, while providing the guidance to keep moving in the correct direction. His enthusiasm for research and depth of knowledge was greatly appreciated. He taught me how to become a quality researcher.

It is said that behind every good man is a good woman. In my professional life here in Split I had a team of three outstanding women that made this foreign experience possible. Aleksandra Banić, Dajana Stolica, and Ivana Banić: I could not imagine having a successful experience here without any of you, for that you have my sincerest gratitude.

I would also like to thank Dr. Stephan Thom and his team for their role in the data analysis of the research and Drs. Otto Barak and Mislav Lozo for working alongside me in the field. Finally, I could not have organized all the volunteers without the help of Robert Kramarić.

Finally I would like to thank my future wife Sheila for her love and support throughout this whole process. For all the late nights, working weekends, holidays, and conferences she supported me unconditionally and kept the home fires burning.

TABLE OF CONTENTS

1. List of abbreviations.....	2
2. Papers included in the dissertation.....	3
2.1. Introduction.....	3
2.2. Combined methodology.....	11
2.2.1. Subjects.....	11
2.2.2. Methods used in the studies.....	11
2.2.3. Experimental protocols.....	14
2.2.4. Statistics.....	16
2.3. Summarized results.....	16
2.3.1. Paper 1.....	16
2.3.2. Paper 2.....	19
2.3.3. Paper 3.....	21
2.3.4. Paper 4.....	24
2.4. Discussion.....	26
2.5. Conclusions.....	31
2.6. Summary.....	32
2.7. Summary in Croatian.....	33
2.8. Curriculum vitae.....	34
2.9. References.....	36
3.0. Papers.....	44

1. LIST OF ABBREVIATIONS

BG bubble grade

C Celsius

CBC complete blood counts

DCS decompression sickness

FiO₂ fraction of inspired oxygen

FMD flow-mediated dilation

HIT high intensity training

HR heart rate

HR_{max} maximal heart rate

IPAVAs intrapulmonary arterial-venous anastamoses

MPs microparticles

MPO myeloperoxidase

MSW meters sea water

O₂ oxygen

PFO patent foramen ovale

SCUBA self-contained underwater breathing apparatus

TTE transthoracic echocardiography

VGE venous gas emboli

VO_{2max} maximal volume of oxygen consumption

W watts

2. PAPERS INCLUDED IN THE DISSERTATION

1. Madden D, Thom SR, Milovanova TN, Yang M, Bhopale VM, Ljubkovic M, Dujic Z. Exercise before SCUBA Diving Ameliorates Decompression-Induced Neutrophil Activation. *Med Sci Sports Exerc.* 2014 Oct; 46(10): 1928-35
2. Madden D, Thom SR, Milovanova TN, Yang M, Bhopale VM, Ljubkovic M, Dujic Z. High intensity cycling before SCUBA diving reduces post-decompression microparticle production and neutrophil activation. *Eur J Appl Physiol.* 2014 Sep; 114(9): 1955-61.
3. Madden D, Barak O, Thom SR, Yang M, Bhopale VM, Ljubkovic M, Dujic Z. The impact of pre-dive exercise on repetitive SCUBA diving. *Clin Physiol Funct Imaging.* 2014 Oct [In press].
4. Madden D, Lozo M, Dujic Z, Ljubkovic M. Exercise after SCUBA diving increases the incidence of arterial gas embolism. *J Appl Physiol* (1985). 2013 Sep 1;115(5):716-22

2.1. Introduction

Open sea SCUBA (self-contained underwater breathing apparatus) diving is an occupational tool as well as a recreational activity. Although diving science has been continuously advancing over the past decades, there remains an effort to increase the safety related to acute and chronic exposures to the undersea hyperbaric environment. With these advances, along with more capable, inexpensive, and user-friendly equipment, the population of divers has grown from elite adventurers to an all-inclusive holiday activity with an estimated 1.2 million divers around the world. While previous empirical development and refinement of diving protocols (decompression tables) has dramatically reduced the incidence of decompression sickness (DCS) (17), cases of “undeserved” DCS are reported in divers who follow safe practices (67). Additionally, the chronic implications of a lifetime of diving are not yet known. It is important to consider that these original diving procedures were developed and tested on military

divers who now represent a small fraction of a diving population that now includes the elderly and those with chronic disease and complications.

In addition to the environment, members of this newer dive population can be on any variety of drugs to treat chronic conditions such as heart disease (8), diabetes (6), pulmonary diseases or cerebrovascular conditions. Recommendations for these populations are scant and mostly advise the use of extremely conservative dive profiles (31, 35). Since holiday diving is the most likely scenario in which these types of divers would be found, consideration must be given to the location and ease of accessing emergency treatment.

Outside of the diving research community SCUBA serves as a unique model for multimodal stress that has usefulness beyond recreational or professional diving. For example, endothelial function is now linked to many clinical manifestations of cardiac disease (57). Studies that investigate dysfunction in healthy subjects often use tools such as a high fat meal to temporarily reduce endothelial function (65). SCUBA diving can accomplish the same thing, only with results that last up to 24 hours or longer (9, 48) rather than 2 to 6. The study of relationship between patent foramen ovale (PFO) and arterialization of venous gas bubbles (VGE), along with conditions that impact them, is useful in stroke research. The mechanisms that allow an air bubble to arterialize could do the same for thrombi thus contributing to stroke risk, thus VGE crossover to the arterial side can be used as a model for thrombotic emboli (18).

Originally, DCS was simply thought to be the result of inert gas bubbles circulating throughout the body following inadequate decompression and occluding blood flow to various organs. Although this has been demonstrated in extreme cases, with autopsies after accidents revealing the complete occlusion of cerebral arteries from gas bubbles (38), this is not a common manifestation of DCS (67). Neurological type II DCS has also been attributed to emboli lodging in the spinal column, while joint pain is attributed to emboli in those locations as well (type I DCS). Despite clear *in vivo* demonstration of these occurrences, the story is not that simple. Data collection over the past few decades has demonstrated that even mild recreational dives can produce large quantities of VGE (23) with no clinical implications (42, 43). Studies that sought to find a relationship between VGE specifically and DCS have not found correlations between the two (25). It is possible that, now with more advanced equipment, researchers can visualize more VGE than would have been possible in the past. Many methods of VGE detection are in use

today and those groups with budgetary constraints may limit the use of high resolution in the field.

Considering these findings of a high number of bubbles in some divers they are not yet considered harmless. Anecdotally, many research groups report that certain individuals may present with a large quantity of bubbles compared to other subjects regardless of the dive profile yet show no signs or symptoms of DCS (in our divers' population ~20%). Although anyone has yet to quantify this observation the "bubble producers" demonstrate some level of individual response. A lack of a strong correlation does not mean the gas bubbles do not play a role in the development of DCS. These gas bubbles are commonly found in the venous circulation, as nitrogen from off-gassing tissues diffuses into the blood as it perfuses through the tissue, and are trapped in the pulmonary microcirculation, and diffuse into the divers exhaled breath. Following this path, VGE have little opportunity to wreak havoc in other tissues as they are headed straight for elimination. However, if bubbles cross over from the venous to arterial circulation (Fig 1) they have more opportunity to interact with sensitive tissues such as the brain (33). Indeed this crossover is associated with a higher incidence of neurological DCS (30, 58, 64).

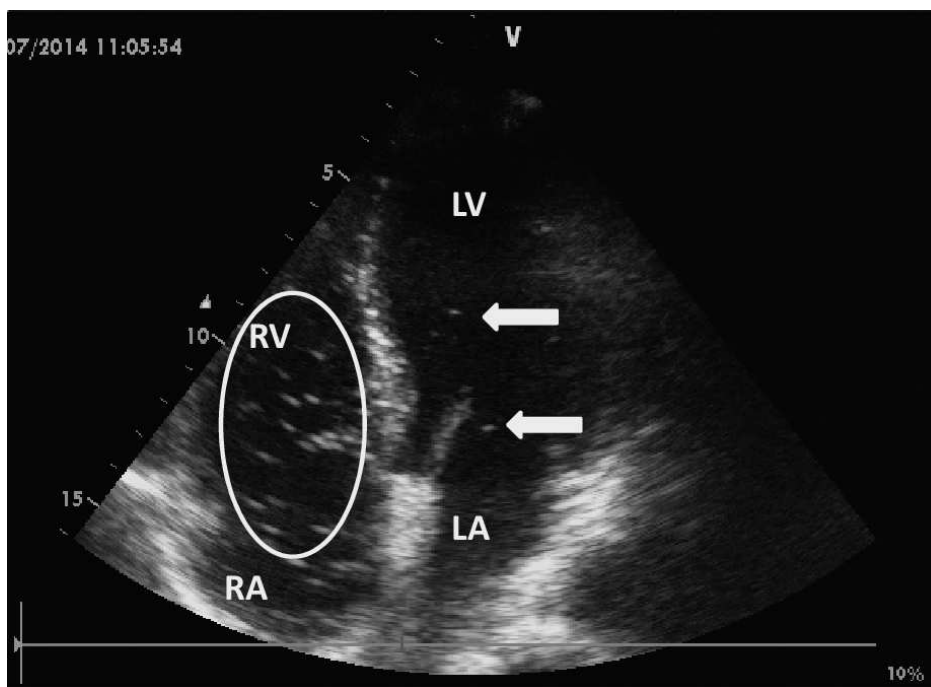

Fig. 1. Image displays arterialization (white arrows) in the left ventricle (LV) and emboli in the right ventricle (RV, white oval). Image was obtained with a Vivid q (GE, Milwaukee, WI) with a cardiac probe on a subject after diving. RA, right atrium; LA, left atrium.

Interaction between SCUBA diving and exercise

The safety of diving and mitigation of decompression stress remains one of the more practical goals of recent SCUBA research. The impact of exercise on diving has been investigated in several studies. Some of these studies utilized simulated dry chamber dives (32), which may not accurately replicate the stress associated with open water diving (54). While a chamber can recreate the hyperbaric experience of diving there are additional factors such as water immersion, increased effort of breathing, and compression from wetsuits that add to the stress of the environment. Currently, exercise is considered by some to be a form of protective preconditioning for SCUBA diving (19, 22, 29); although these claims have been based on animal survival studies (71) or decreased VGE in humans after aerobic exercise. The execution of preconditioning includes some sort of procedure completed before diving to mitigate decompression stress and decrease the risk of DCS. In addition to exercise procedure such as antioxidants, whole body vibration, hyper hydration, heat treatment, and oxygen breathing have been tested (29). Proposed mechanisms of exercise preconditioning include altered hemodynamics (3), increased nitric oxide concentration and improved vaso-reactivity (22).

Exercise protocols tested before diving varied in intensity from 60% age-predicted maximal heart rate (HR_{max}) (4) to intervals at 90% HR_{max} (19), with running as the mode of exercise. Studies examined interactions of exercise with diving within 2 (3, 4, 10) or 24 hours (19) prior to diving. In these studies exercise reduced the quantity of VGE to varying degrees which is why some consider it a form of preconditioning. Although many of these studies were conducted in the open sea, whether or not a reduction in VGE alone is enough to mitigate decompression stress is yet to be determined. There has been little discussion of mechanisms other than VGE reduction such as preservation of endothelial function or a reduction in platelet aggregation and MP expression.

Exercise during decompression stop has been evaluated as well, with the goal of decreasing the time it takes to clear VGE from the blood secondary to an increase in cardiac output (69). While this was intended to reduce the time of nitrogen washout before a spacewalk, it has been used during decompression stops under sea while diving to reduce the VGE load (21). In this study mild exercise, fin swimming at 30% VO_{2max} , during a decompression stop resulted in a significant reduction of VGE.

Research on the impact exercise after diving is limited at this time and limited primarily to the chronic effects. Blatteau et al. examined the impact of strenuous exercise interspersed between diving sessions over a period of time and found a slight increase (41 to 47%) in the prevalence of right-to-left shunts in these divers (5). Another study reported a single case of pulmonary shunt after diving during exercise but concluded it was a rare event (55). The same group examined the effect of cycling up to 85% VO_{2max} after a dive in a small group of divers and observed a decrease in VGE with no observation of shunting (20). Timing of exercise, related to diving and decompression, appears to be important.

Microparticles and diving

Due to the complexities of the relationships between gas bubbles, DCS, and decompression stress, their measurement alone may not be the best method of quantifying DCS risk. Despite this, a majority of studies continue to rely on VGE as a surrogate marker for decompression stress, which may not tell the whole story. There are other measures of decompression stress that may be quantified follow a dive, and likely contribute to the pathophysiology resulting in DCS. These include platelet activation (56), endothelial dysfunction (49, 52), reactive oxygen species (12), markers associated with vascular damage (2), and microparticles (MPs) (60).

Microparticles are fragments released from the cytoplasm of whole cells or fragments of lysed cells, once thought to be inconsequential waste, in the circulation. MPs range in diameter from 0.1 to 1.0 μm and may contain a lipid bi-layer, protein aggregates, and other cellular debris. Once thought to be useful simply as biomarkers of physiological/pathophysiological stress, newer research has linked them to pathogenesis of many chronic conditions including certain cancers (1) and cardiac disease (27), therefore increasing interest in activities, such as exercise and diving, that result in an increase in MPs. They increase with traumatic and inflammatory disorders, and may serve as intercellular messengers because they can directly stimulate the release of cytokines or other signaling proteins, mRNA, and micro-RNA (51). MPs are characterized by the surface expression of antigenic markers from their parent cells and many also have surface-bound annexin V because, as they are formed, negatively charged phosphatidylserine residues become exposed. Annexin V-positive platelet derived MPs exhibit pro-coagulant properties in addition to leukocyte activation and aggregation (14). Research in the murine model has been interesting enough to warrant further investigations in human subjects.

Due to the highlighted relationship between MPs, inflammation, and vascular damage Thom et al. hypothesized that MPs generated during decompression play a role in the pathogenesis of DCS, and, that abatement of such MPs would disrupt the process that leads to injury (62). This was demonstrated in mice where an abatement strategy resulted in significantly lower tissue damage in the brain, omentum, and psoas (63). Animal studies have the advantage of potentially producing more concrete evidence since protection from DCS can be observed as changes in survival rate and they can be sacrificed to achieve a deeper level of tissue analysis. The disadvantage to such studies is, despite the similarities in all mammals, there are limits to the translation between human and animal models.

Yang et al. hypothesized that some MPs contain an inert gas core, which may serve as a nucleation site for nitrogen as it is released from the saturated tissues during decompression, resulting in VGE (72). An increase in these so called enlarged MPs (1.0 to 3.0 μm in diameter) was found in mice immediately decompression and continued to increase for 24 hours. The theory of the gas core was supported by hydrostatic recompression of MP samples. There was a significant reduction in large MPs following recompression with no change in the normal sized MPs. Next, mice were injected with enlarged MPs and recompressed MPs. The result was a decrease in markers of platelet and neutrophil activation and vascular damage in the mice injected with the recompressed smaller MPs (72).

Follow up diving studies in human subjects demonstrated an increase in MPs and associated inflammatory parameters as well (60, 61). In these studies, the increase in MPs was correlated with increased neutrophil activation and interaction with platelets. In the follow up study, the number of large MPs ($> 1.0 \mu\text{m}$) was correlated with bubble grade in certain conditions. Although these human trials cannot be taken to the same extreme as the murine studies the similarities in MP increase and expression following diving remain. If these alterations play a role in the body's reaction to decompression, as well as DCS, it is possible that previously researched preconditioning techniques, such as exercise that were evaluated on VGE alone, could have other beneficial or harmful effects on other parameters such as MPs.

IPAVAs and diving

While there is little research on exercise after diving, following decompression to atmospheric pressure, there are a few studies that suggest this may be harmful to the diver. This theory is based on the idea that exercise can increase the incidence of arterialization of VGE.

Emboli found following a dive vary in size from 19 to 700 μm (37) while the diameter of the capillaries at the site of gas exchange in the lungs ranges from 6 to 15 μm . This essentially traps the bubbles and they diffuse into the lungs to be exhaled. Previously, agitated saline was used to create contrast bubbles in order to visualize arterialization through special larger diameter vessels in the lungs in the absence of a PFO. The presence of PFO is determined through the injection of contrast bubbles into the venous circulation and observing if, and how soon, they cross over to the left chambers of the heart (fig 2).

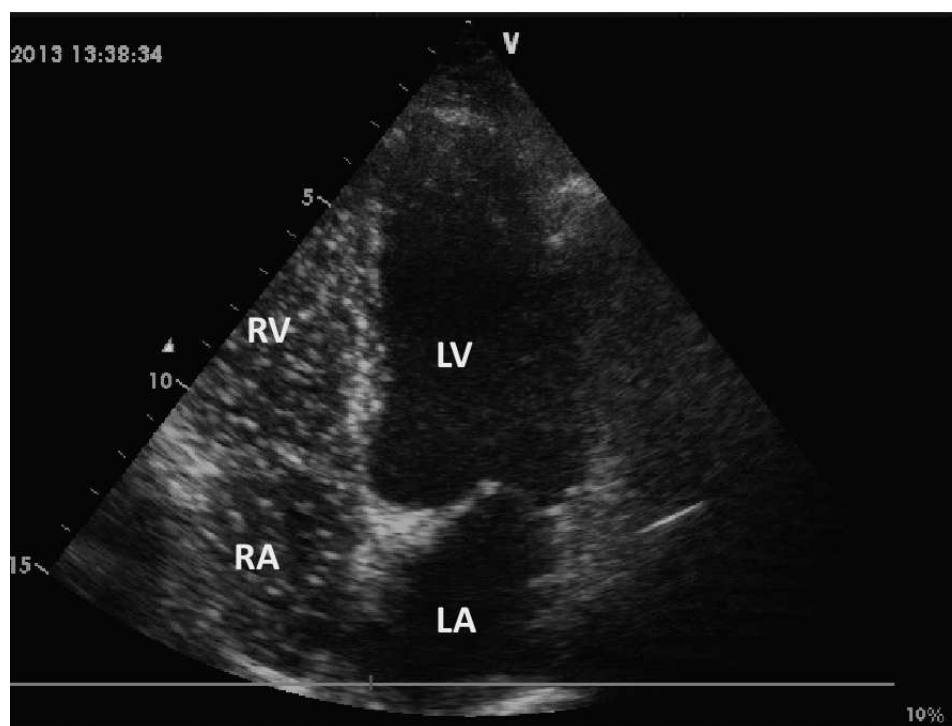

Fig. 2. Image displays grade 4C near “white out” in right cardiac chambers with empty left chambers indicating no PFO as long as LV and LA remain clear for 4 cardiac cycles. The appearance of bubbles after 4 cycles indicates pulmonary shunt. RA, right atrium; LA, left atrium; RV, right ventricle; LV, left ventricle.

The pulmonary vessels that allow arterialization are called intrapulmonary arterial-venous anastomoses (IPAVAs), are not always open, and can be up to 60 μm in diameter (46); large enough to allow the passage of bubbles. Other characteristics of IPAVAs originally found in the lab are also interesting to divers in the field. Most notable are that IPAVAs open more readily when breathing hypoxic gas mixtures at rest and during exercise (FiO_2 0.12) (44) and close when

breathing (100% O₂) (45), as well as how they behave during exercise (26, 39, 59) or under combinations of these conditions (44). Although the exact physiological role of IPAVA is not yet clear, recent studies have found that they open during physical activity and may serve to help reduce pulmonary arterial pressure and therefore, right heart afterload (44, 59). The intensity of VO₂ consumption at which this occurs is variable, ranging from rest to maximal effort, with few subjects not showing any evidence of opening at all (26). Commercial and military diving may involve physical activity during decompression related to the nature of the job. Recreational divers as well often must be active immediately following a dive; activities such as surface swimming back to the boat or walking carrying heavy gear could easily reach and surpass the workload that elicits the opening of shunts, especially for those whose shunts open at a relatively low percentage of their VO_{2max}.

The present body of research suggests that exercise before diving and during recompression may be beneficial. Laboratory studies have shown that exercise can open up large diameter pathways in the pulmonary circulation facilitating the arterialization of gas bubbles. Therefore understanding the timing of exercise is important and may determine whether it is beneficial or potentially harmful. VGE alone may not be the best way to determine the efficacy of exercise. Other parameters, such as MPs and endothelial function, may provide additional markers of decompression stress, as well as provide insight to the pathogenesis of DCS. Given the above, the aim of this dissertation is to test the following hypothesizes in a series of studies:

1. Exercise before diving will impact MP counts and expression following the dive compared to a control dive of equal depth and duration.
2. The mode, intensity, and duration of exercise are related to the outcome, and alterations of these variables will impact MP expression
3. Repeated dives with exercise will have different outcomes than a single dive due to a potential acclimatization (73) or an increase of global fatigue.
4. Exercise of increasing intensity following a dive will cause most people to arterialize once the threshold intensity is reached. This arterialization would stop once the exercise is terminated.
5. Breathing 100% O₂ during exercise, that was intense enough to provoke arterialization, will prevent these incidents.

2.2. Combined methodology

2.2.1. Subjects

The subjects were recruited from the Croatian navy and police dive units, or volunteer search and rescue divers. The subjects were apparently healthy prior to the studies and recently given clearance to dive by a physician. No subjects reported previous cases of DCS. After receiving a written explanation and an oral briefing of the methods and potential risks for each study, all subjects gave their written informed consent. All studies were approved by the University of Split School of Medicine Ethics Committee and all procedures were conducted in accordance with the Declaration of Helsinki.

2.2.2. Methods used in the studies

Anthropometry. Height, weight, and percent body fat for each subject was measured before diving. Percent body fat was estimated by measurement of subcutaneous skin fold thickness with a caliper (Harpenden skinfold caliper, Baty International, West Sussex, England) at the three sites as dictated by the Jackson Pollock equations for male and female subjects.

Spirometry. Pulmonary function assessment including forced vital capacity and maximal voluntary ventilation tests were performed (Quark PFT, Rome, Italy).

Treadmill VO_{2max} testing protocol. The VO_{2max} test was an incremental test conducted on a treadmill (Cosmed T165 sport, Rome, Italy) beginning at 3 km/h and 2% grade and increasing 1 km/h every minute until voluntary termination or at least two of the three following requirements were met: 1) A plateau of VO_2 (<150 mL absolute increase) or heart rate (HR) with an increase in workload, 2) respiratory exchange ratio > than 1.1 and 3) HR in excess of 90% of age predicted ($220 - \text{age}$) maximal values. Once these criteria were met, the highest five second average VO_2 was selected as the subject's maximal value.

PFO screening. A 20-gauge catheter was placed in the left cubital vein and a three-way stopcock was attached with two syringes connected to its ports. One syringe contained 9 ml of saline and 1 ml of blood, and the other syringe contained 1 ml of air. The contrast bubbles, created by alternating the plunger depression six to eight times, were injected as a bolus while images were simultaneously obtained in the apical four-chamber view. The contrast agent was injected at rest and during a Valsalva maneuver. After injection, the presence of contrast bubbles was examined in the cardiac cavities by TTE for a duration of three minutes. Rapid filling of the

left cardiac cavities with contrast bubbles within three to four cardiac cycles observed at rest or after a Valsalva maneuver was indicative of PFO (Fig 2).

Trans-thoracic echocardiography (TTE). The divers were placed in the supine position where a dual frequency (1.5-3.3 MHz) ultrasonic probe connected to a Vivid q echographic scanner (GE, Milwaukee, WI, USA) was used to obtain a clear apical four chamber view of the heart.

Bubble grading. Bubbles were recorded and graded on a scale of 0 to 5 with 4 being subdivided into 4A, 4B, and 4C, according to the method described by Eftedal and Brubakk (24), and later modified by Ljubkovic et al. (41). In addition to monitoring scores at rest, VGE were graded after two different movements, arm and leg contractions, to mobilize bubbles that may be lodged in the venous circulation.

Flow-mediated dilation. Measurements were performed with a Vivid q echographic scanner (GE, Milwaukee, WI, USA) fitted with a 5.7 to 13.3 MHz linear probe. Images of the longitudinal brachial artery (including the lumen-intima interface on anterior and posterior walls) were stored for later analysis. Once a baseline image was obtained, arterial occlusion was created by inflating a cuff placed on the forearm to 250 mmHg for five minutes. Next, the cuff was deflated, producing a high-flow state resulting in arterial dilation. FMD was calculated as the percentage increase in brachial artery diameter from baseline to peak dilation measured after occlusion. Measurements were made with previously recorded video using Vascular Research Tools 6 software (Medical Imaging Applications-LLC, Coralville, IA, USA).

Repeated Wingate protocol. Anaerobic intervals were performed on a weight braked bicycle ergometer (Monark 894E, Vansbro, Sweden) consisting of 4 x 30 sec maximal efforts (resistance set at 7.5% body mass) with four minutes of active recovery (cumulative time 23 minutes including warm up) spaced at least three days apart from the control dive.

Running protocol. Subjects completed a 20 minute self-selected jogging warm up (up to 20 beats per minute below prescribed interval HR) immediately followed by 40 minutes of intervals (three minutes at prescribed intensity with two minutes active recovery repeated eight times) at an intensity corresponding with 90% of HR at VO_{2max} for a total of 60 minutes of running. The run was conducted in a natural park (for study 3, on a treadmill for study 2) on the same site as the dive location. Subjects ran on their own and controlled their effort via HR with a monitor (Garmin Forerunner 305, Garmin International, Olathe KS, USA).

Detection of shunts during exercise. The subject was seated at an electronically braked cycle ergometer in an upright position. The torso was strapped into a support device designed to immobilize the torso, and the left arm was moved into the abducted and externally rotated position. The subjects completed a single incremental exercise bout with a starting workload of 60 watts and a 30 watt increases every two minutes. After beginning exercise, on the first appearance of bubbles in the left heart the exercise was immediately suspended while TTE observation of the heart continued. The criterion for clearance of the bubbles was 20 consecutive cardiac cycles without appearance of bubbles in the left heart. Once the left heart was clear of bubbles, exercise was resumed at the same intensity from which it was suspended when the shunting occurred. The subjects continued with the protocol until bubbles were again observed in the left heart. At this second occurrence of arterialization, exercise was terminated and oxygen at a concentration of 99.5% O₂ was immediately given. Expired gasses and heart rate were monitored and recorded during the initial VO_{2max} test and during the exercise protocols after diving via a portable metabolic system (Cosmed K4 B², Rome, Italy).

Microparticle flow cytometry. Flow cytometry was performed with an 8-color, triple laser MACSQuant (Miltenyi Biotec Corp., Auburn, CA) using the manufacturers' acquisition software Gates were set to include 0.3- to 5.0 µm particles, with exclusion of background corresponding to debris usually present in buffers. MPs were stained with annexin V antibody and analyzed as previously described, including micro-beads with diameters of 0.3 µm (Sigma, Inc.), 1.0 µm, 3.0 µm and 5.0 µm (Spherotech, Inc., Lake Forest, IL) to assess the size of particles. We define MPs as annexin V-positive particles with diameters up to 1 µm. Analysis of neutrophils was performed on fixed blood samples as previously described in Thom et al (60). Platelet activation was assessed by staining samples with CD41 and annexin V antibodies in samples that included micro-beads with diameters of 3.0 and 5.0 µm. Platelets were identified as particles between these micro-bead size limits that were CD41-positive and annexin V-negative and activation assessed as surface expression of CD63 and CD62b analogous to procedures described by others (66).

CBC analysis. Whole blood samples were obtained from the subjects before exercise (exercise protocols only) or the control trials, approximately 30 minutes before diving, and 15 minutes after surfacing. Blood was stored in a cooler and transported to the Department of Biochemistry, University Hospital Split, for analysis within two hours of obtaining the sample. Complete blood

count (CBC) values were measured with the Abbot Cell-Dyne 4000 cell counter (Abbot Park, IL, USA).

2.2.3. Experimental protocols

All diving took place at a Croatian naval installation, while laboratory work, exercise testing, and anthropometry were conducted at the laboratories of the Department of Integrated Physiology in the University of Split School of Medicine. Blood samples were analyzed at the Pennsylvania Medical University and the University of Maryland. Treadmill exercise was completed at a local health club convenient to the dive location while outdoor running was completed in a natural park connected to the Croatian navy installation. Diving procedures varied little between the four studies, only in the bottom time. The standard dive protocol was performed at a depth of 18 meters sea water (msw) with a bottom time of 41 minutes. This dive profile was selected with dive planning software built into Galileo dive computers (Uwatec Galileo Sol, Johnson Outdoors, Racine, WI, USA) which were also used to verify subject adherence to the dive protocol. Decompression was performed at a rate of nine msw/minute, with a direct ascent to the surface. Throughout the dive, divers performed swimming of subjectively moderate intensity and HR was monitored via dive computers.

A small pilot study was conducted to observe the MP response following three different types of exercise. The goal was to compare a treadmill protocol, which has proven to be beneficial to divers related to VGE production in a previous study (8), to a similar protocol performed on a cycle ergometer, and an anaerobic protocol. Wingate cycling was chosen for the anaerobic trial because of the relative safety compared to equivalent anaerobic efforts performed on a treadmill. These trials were conducted two months prior to the beginning of the study to determine what exercise protocol should be used before diving. Briefly, the following protocols were performed each with four subjects: 1) Intervals on a bicycle ergometer consisting of three minutes at VO_{2max} power (W) and 1.5 minutes of active recovery. The intervals were repeated until the subject could no longer maintain 90% of VO_{2max} power (cumulative time 15 to 18 minutes), 2) Repeated Wingate tests on a bicycle ergometer consisting of 4 x 30 second maximal efforts with four minutes of active recovery (cumulative time 23 minutes including warm up) and 3) Treadmill intervals consisting of three minutes at a velocity that elicited 90% of HR_{max} determined by prior testing and two minutes at 50% repeated eight times (cumulative time 60 minutes). Treadmill interval exercise (protocol 3) was selected for study 1 for two reasons; it is the same protocol

utilized in an earlier exercise and simulated dive study (8) shown to decrease VGE, and the MP response was more pronounced and prolonged compared to the cycling protocols (data not shown).

Cycling was chosen for use after diving so the torso could be held still enough to allow TTE to be performed while exercising. A ramp protocol was selected so we could observe the effect of increasing intensity and determine if there was an individual threshold which would result in arterialization.

Study 4 examined only one dive per subject followed by incremental exercise while performing TTE in order to view emboli in the right and left heart. 100% O₂ was given to those who arterialized to determine its effects on right to left shunt. Studies 1 and 2 compared MPs and VGE following diving in subjects who served as their own matched controls. Study 3 utilized a crossover design and the protocol is depicted in figure 3 below.

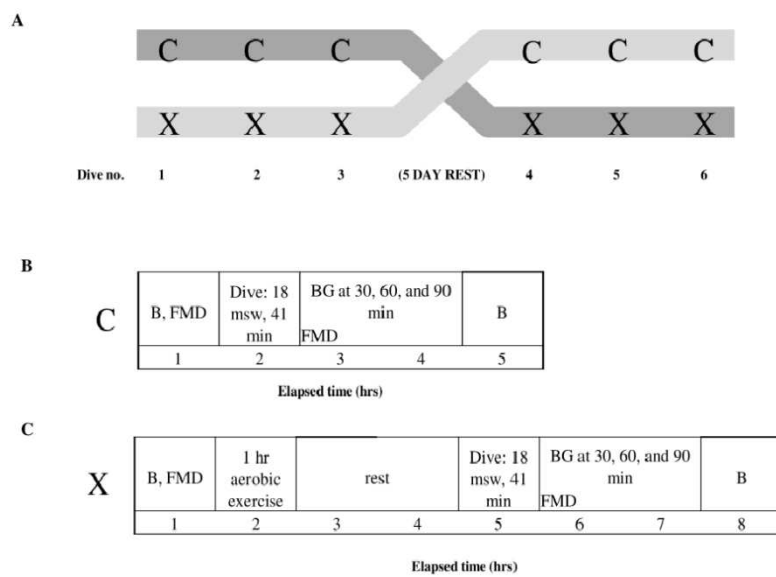

Fig. 3. A. Study protocol for G1 (dark shaded track) and G2 (light grey track). Numbers along x-axis represent dive no. C = control protocol, detailed in **1B**, and X = exercise protocol, detailed in **1C**. Numbers along x-axis in **1B** and **C** represent elapsed time in hours.

2.2.4. Statistics

After analysis of distribution with the Shapiro-Wilk test, MP counts, platelet, and neutrophil activation were analyzed by repeated measures analysis of variance (ANOVA) followed by a Bonferroni correction. Bubble grades were analyzed with the Wilcoxon signed-rank test. The Students T test was used for within-groups comparisons.

2.3. Summarized results

2.3.1 Paper 1

Data for the 14 males and 5 females are grouped together. The median bubble score, taken at rest, was unchanged between the exercise and the control dive. Platelet counts were significantly reduced following the exercise dive compared to the control dive at all measured time points after surfacing (15 min $p=0.013$, 2 h $p=0.037$, 4 h $p=0.002$, and 24 h $p=0.003$). Leukocytes were significantly increased by exercise when measured before diving ($p=0.0002$) and were also significantly increased by diving during both the exercise and control dives ($p=0.000$ and $.002$).

Circulating MP and enlarged MP counts related to the exercise and control dive are displayed in Figures 4A and 4B respectively. There was no significant difference in annexin V-positive MPs (0.3-1 μ m) before exercise and before diving on the day of the control dive, indicating no difference in baseline among divers before the two different dive conditions. MPs increased significantly at all time points up to four hours after surfacing in both dives. There was a significant difference in MP number between exercise and control dives at all four post-dive measurements, with lower response in the exercise group. Elevated MP values persisted for 24 hours following both dive conditions but were only significant following the control dive. Elevations of large MPs occurred following the control dive in a pattern similar to the 0.3 to 1 μ m MPs, but not following the post-exercise dive (Fig 4).

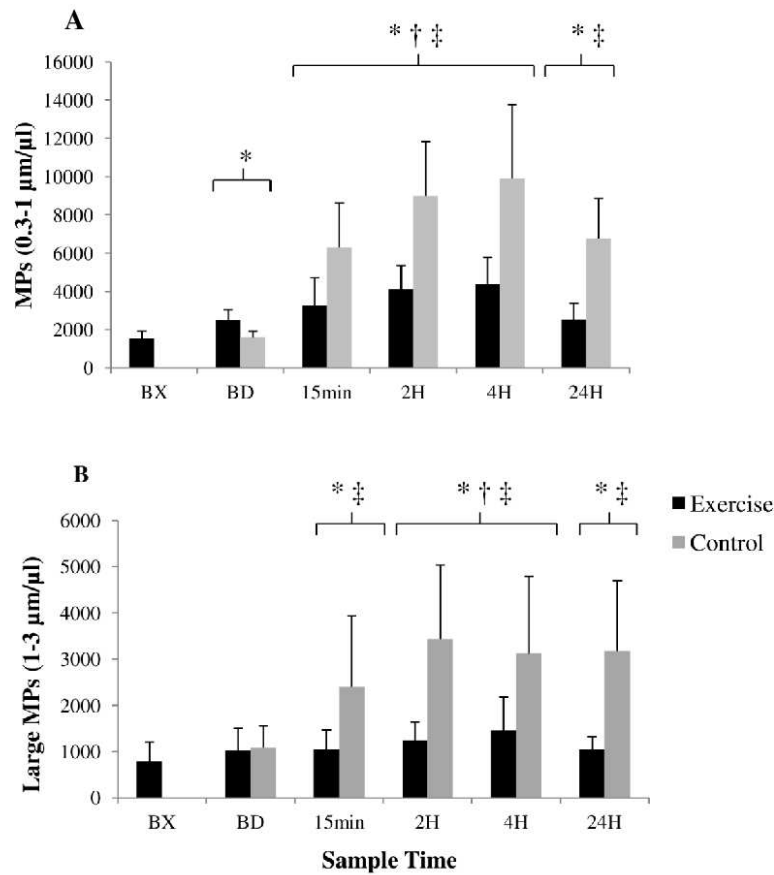

Fig 4. Data show mean of circulating **A.** MPs (0.3 – 1.0 µm)/µl and **B.** enlarged MPs (1.0 – 3.0 µm)/µl. BX = Sample taken before exercise (EX dive only). BD = sample taken before diving, both dives. *Value significant differences in MP count at same time point between EX and CON dives. Value significantly different from BD values in EX dive † and CON dive ‡.

Neutrophil activation was assessed as surface expression of CD18 and myeloperoxidase (MPO) on CD66b-positive cells (Fig. 5A and 5B). Activation occurred after the control and exercise dives with a significant difference at all post-diving measurements of CD18 and at 15 minutes, 2 and 24 hours for MPO. Platelet-neutrophil interactions were evaluated as the presence of CD41 on CD66b-positive cells (Fig. 5C). Notably, there was an increase of CD41 fluorescence following pre-dive exercise, mean fluorescence and remained elevated following the dive. Following the control dive, fluorescence was increased compared to both pre-dive values and compared to all time points of the exercise dive.

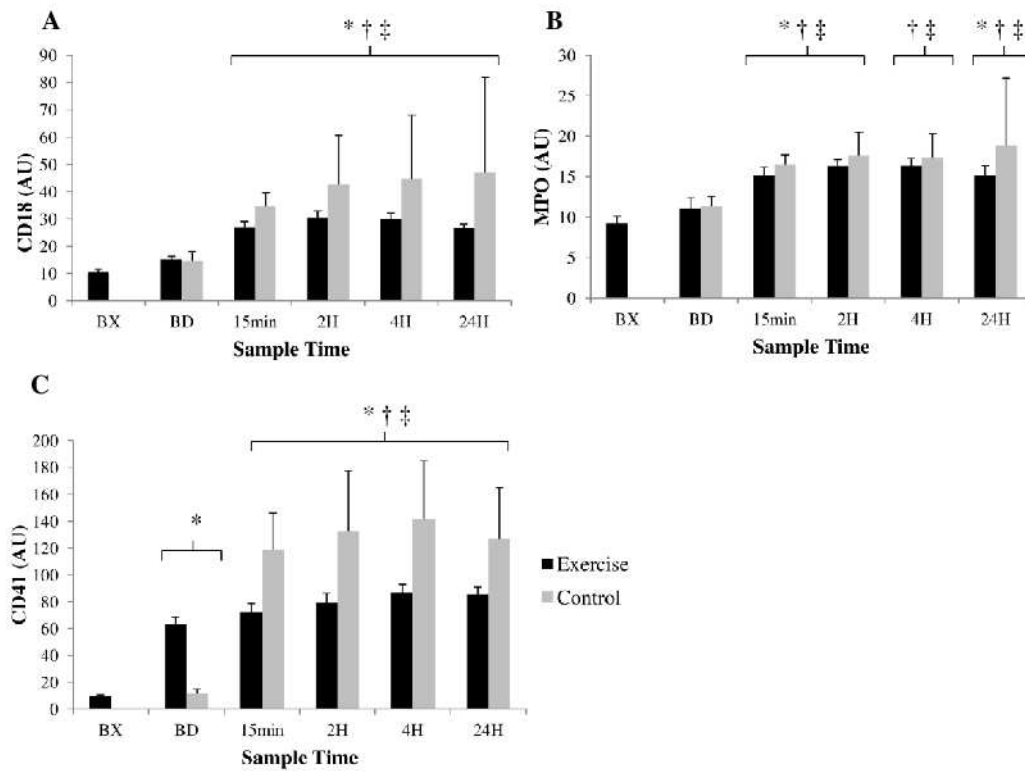

Fig. 5. Neutrophil activation identified by CD66b staining and co-expression of **A. CD18**, **B MPO**, and **C CD41** shown as geometric mean fluorescence AU (arbitrary units) for each marker. BX = Sample taken before exercise (EX dive only). BD = sample taken before diving, both dives. *Value significant differences in MP count at same time point between EX and CON dives. Value significantly different from BD values in EX dive † and CON dive ‡.

2.3.2 Paper 2

There were no adverse effects reported from any of the subjects after exercise and SCUBA diving activities. Median bubbles grades were significantly lower in the cycling group (median BG of 3 compared to 4B, $p=0.028$) at the 15 minute measurement. No significant differences between the groups were observed at 40, 80, or 120 minutes post-diving (data not shown).

There were no significant differences in leukocyte, erythrocyte, hematocrit (Hct), or thrombocyte counts following the Wingate protocol and before diving (data not shown). Leukocytes were significantly higher 15 minutes after surfacing following both the cycling ($p=0.014$) and control ($p=0.002$) protocol compared to pre dive values.

Circulating MPs and enlarged MPs related to the exercise and control protocols are displayed in Figure 6. Total MP counts are elevated following both protocols. This increase is significantly lower at both time points following the cycling protocol ($p=0.011$ 15 minutes and $p=0.008$ 120 minutes). Enlarged MP (size 1 to $3\mu\text{m}$) counts were lower at both measurements in the cycling protocol as well ($p=0.002$ and 0.001).

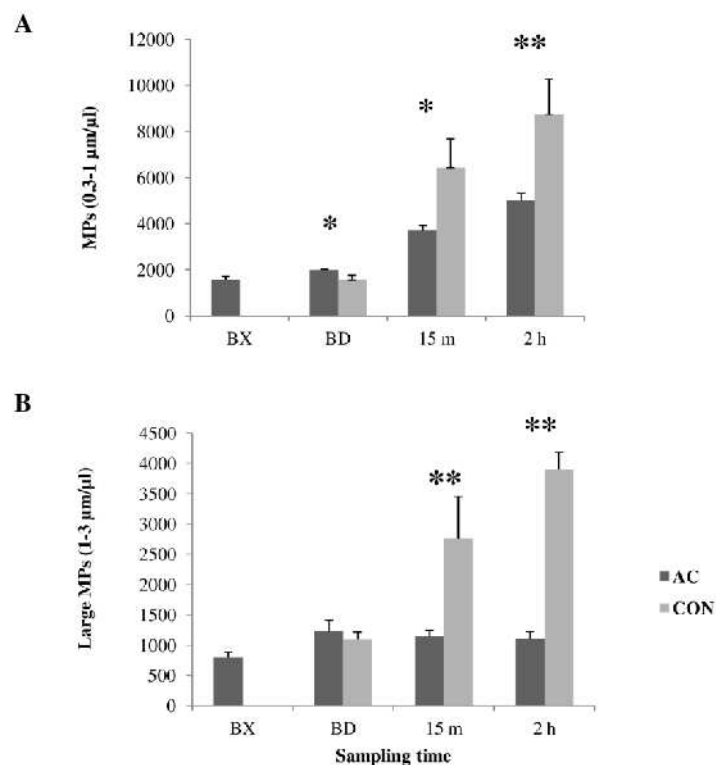

Fig. 6. Total circulating MPs and enlarged MPs. Data show mean of circulating **a** MPs (0.3 – 1.0 μm)/ μl and **b** enlarged MPs (1.0 – 3.0 μm)/ μl . BX = Sample taken before exercise (AC dive only). BD = sample taken before diving, both dives. * $P < 0.025$, ** $P < 0.01$, significance between MP count at same time point between AC and CON dives.

Neutrophil activation was assessed as surface expression of CD18, myeloperoxidase (MPO), and CD41 on CD66b-positive cells and is displayed in Figure 7. All parameters were elevated following SCUBA diving. There was no significant difference at any time point in MPO mean fluorescence between both conditions. Following the AC dive, there was less of an increase in CD41 fluorescence at both time points, and in CD18 at the 15 minute time point.

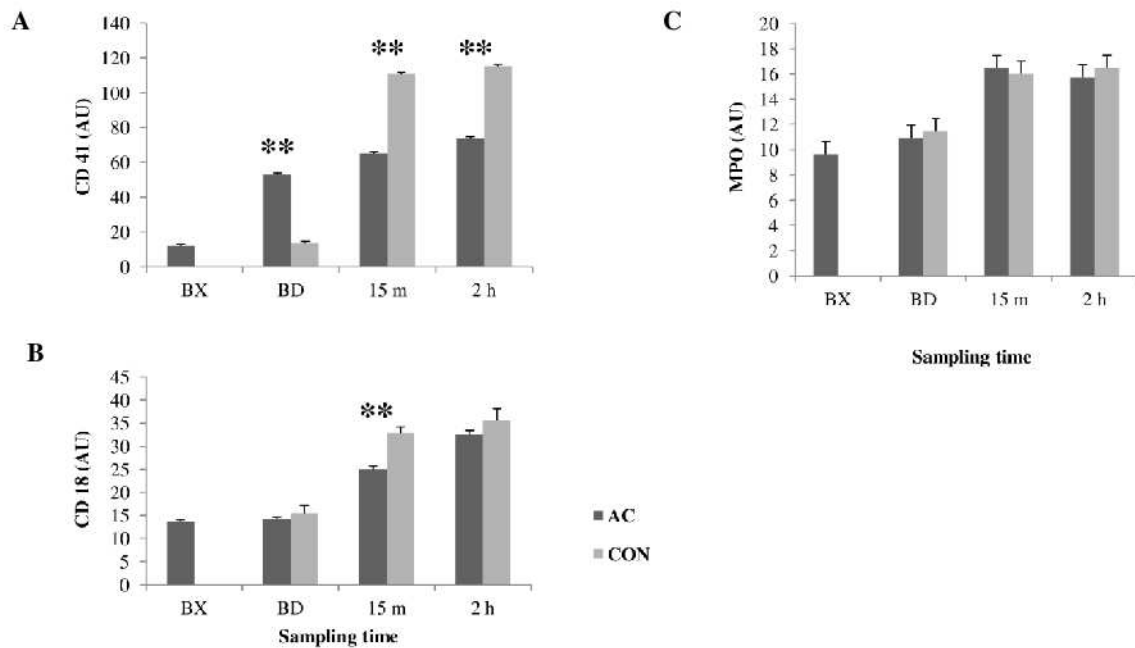

Fig.7. Geometric mean fluorescence representing neutrophil activation. Neutrophil activation identified by CD66b staining and co-expression of **a** CD41, **b** CD18, and **c** MPO, shown as geometric mean fluorescence AU (arbitrary units) for each marker. BX = Sample taken before exercise (AC dive only). BD = sample taken before diving, both dives. * $P < 0.025$, ** $P < 0.01$, significance between expression at same time point between AC and CON dives. AC, anaerobic cycling. CON, control

2.3.3 Paper 3

In this study, exercise did not have a significant impact on BG at rest for any time point in all groups. When comparing subjects strictly by sex, females as a group, had a lower median resting BG at nearly every measured time point compared to the males (table 1). There was no significant difference in the incidence of arterialization between the two groups, male and female, or exercise and control protocols.

Table 1. Median bubble grade at rest 30, 60 and 90 min after surfacing

Dive	30 min					
	Control dives			Exercise dives		
	1	2	3	1	2	3
Male	3	3	3	4A	3	3
Female	1*	2*	1*	1*	2*	1*
	60 min					
Male	3	3	3	4A	3	3
Female	2	3	2*	2*	2	0*
	90 min					
Male	3	2	2	3	2	2
Female	1*	1*	0*	1*	1*	0*

Values represent median BG on Brubakk scale. Male and female subjects are compared within each dive, separately from assigned groups. * $p \leq 0.05$ compared to male subjects.

Endothelial function was assessed through FMD and is displayed as the percent change in peak arterial diameter before and after forearm occlusion in Figure 8. All subjects throughout the entire protocol experienced a significant decrease in FMD after diving. There was no significant difference in FMD between exercise and control conditions. The pre dive FMD values for both groups were significantly lower on dive three compared to dive one.

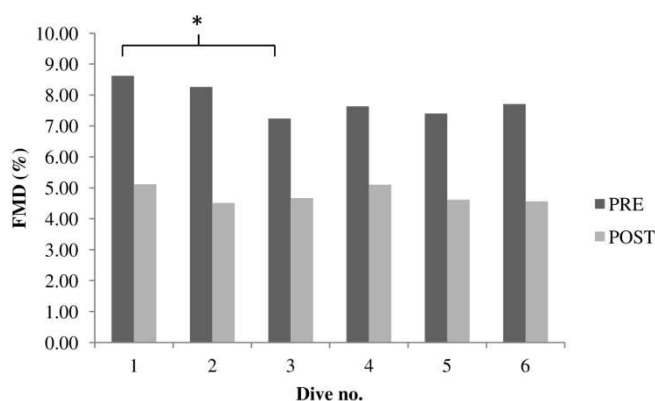

Fig. 8. Flow mediated dilation. Data show pre (dark shaded bars) and post (light grey bars) Δ FMD % for all divers in chronological order. *, $p < 0.05$ between dive 1 and 3 for all divers.

Circulating MP counts are displayed chronologically in figure 9A. There was no significant difference in annexin V-positive MPs between the two groups. Additionally, when comparing the exercise and control protocol within each individual group, there was no significant difference. However, both groups had significantly reduced MP counts (G1 $p = .0008$, G2 $p = .0001$) in the second series of dives. This reduction occurred regardless of performing the exercise or control protocol during the second series.

Neutrophil activation was assessed as the percentage of surface expression of CD18 and myeloperoxidase (MPO) on CD66b-positive cells (Fig. 9B and 9C). In G1 there was no significant difference between exercise and control conditions. In G2, MPO% was decreased ($p = .001$) in dives four through six (control) compared to dives one through three (exercise). There was no significant change throughout the dives in both groups in the percent of CD66b-positive cells expressing CD18. As with circulating MPs, both groups show a significant decrease in the second series of dives compared to the first (G1 $p = .035$ G2 $p = .003$).

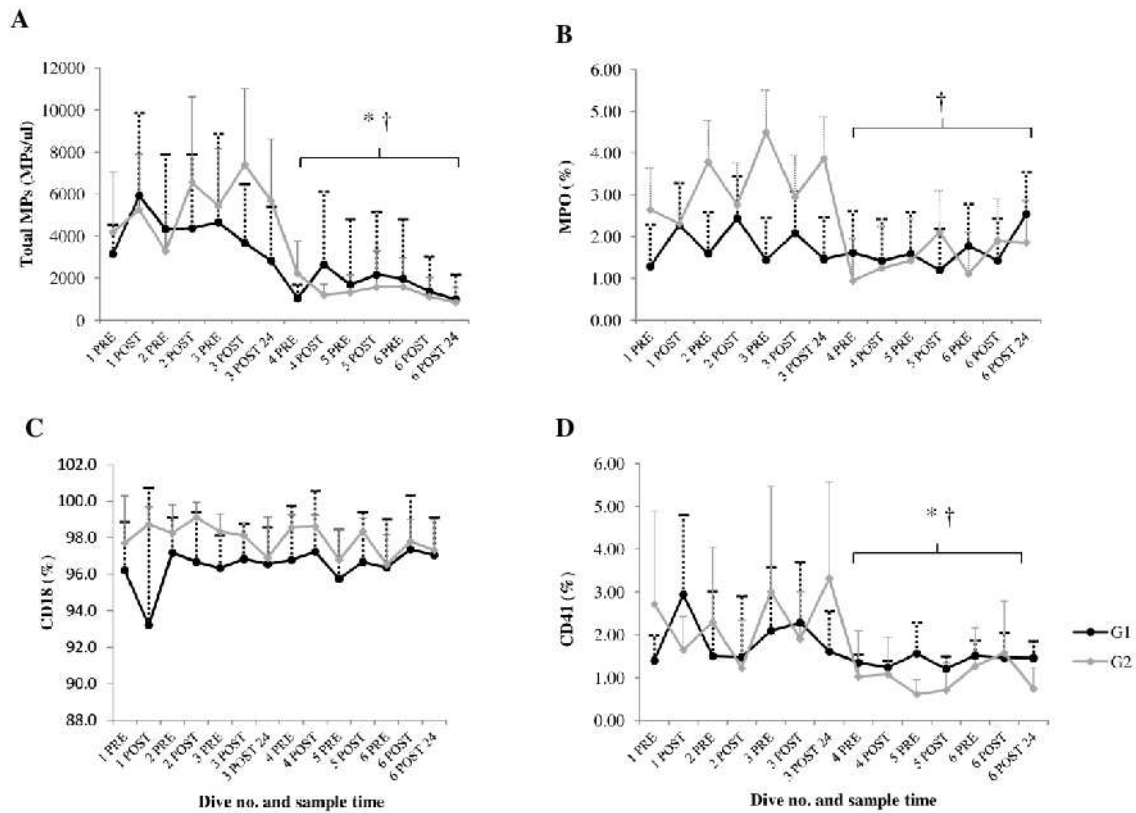

Fig. 9. Microparticle counts, neutrophil activation and platelet interaction. Data show mean of circulating **A.** MPs (0.3 – 1.0 μm)/μl and neutrophil activation identified by CD66b staining and percent co-expression of, **B.** MPO, **C.** CD18, and **D.** CD41. * and †, $p < 0.05$ in G1 and G2 for second series compared to the first series.

2.3.4. Paper 4

23 experienced divers (20 male and 3 female) age range of 23 – 65 years participated in the study. Subjects selected have either been tested negative for patent foramen ovale (PFO) within the past three years or were screened prior to participation in the study.

In subjects 1 – 3 (not shown) we detected gas bubbles in both the right and left sides of the heart at rest. These divers then completed the oxygen protocol. Subjects 4 – 23 displayed a range of emboli (BS 0 – 4B) in the right heart at rest, but without apparent arterialization, and advanced to the exercise protocol. Subjects 4 – 15 (table 2) displayed arterialization at some point during exercise to VO_2 max, while in subjects 16 – 23 (not shown) we did not observe arterialization at any point during the study.

Table 2. Selected parameters observed leading to arterialization with exercise

#	Rest			1st exercise arterialization						2nd exercise arterialization						
	BG		Time of ex onset	Time of art	BG		% VO_2 max	power (w)	time to close	Time of ex resume	Time of 2nd art	BG		% VO_2 max	power (w)	Time to close w/O ₂
	R	L			R	L						R	L			
4	1	0	36:23	42:57	3	1	81	150	00:01:23	44:48	*	*	*	*	*	*
4	A	0	37:46	40:32	3	1	25	60	00:00:58	41:57	46:00	3	1	22	60	01:09
6	A	0	38:38	42:34	A	1	45	90	00:01:18	43:03	*	*	*	*	*	*
7	4B	0	38:32	41:45	A	1	32	90	00:00:30	44:25	45:06	A	1	46	90	00:29
8	3	0	37:49	44:52	A	1	60	150	00:02:34	47:42	48:18	A	1	56	150	00:34
9	4B	0	37:18	45:15	4B	2	48	150	00:01:20	46:51	48:14	4B	1	56	150	01:02
10	3	0	30:00	30:47	4B	2	23	60	00:00:47	32:20	32:45	4B	2	38	60	00:40
11	4B	0	43:00	45:25	4B	2	55	135	00:02:45	48:30	51:00	4B	2	38	60	00:51
12	A	0	34:10	40:52	A	1	30	150	00:01:21	42:24	44:15	A	1	79	150	01:00
13	3	0	39:24	50:40	3	1	92	210	00:01:40	54:10	54:58	3	1	94	210	00:33
14	A	0	36:25	40:41	A	1	50	120	00:01:03	42:03	42:46	A	1	41	120	00:30
15	3	0	32:58	33:40	A	1	31	60	00:50:00	35:00	36:00	A	1	28	60	00:49

#, subject number. R, right cardiac chamber. L, left cardiac chamber. BG, bubble grade. W, watts. *, no 2nd arterialization observed.

The exercise intensity, as % VO_2 max, at which arterialization was first observed in subjects 4 - 23 is displayed in Figure 10.

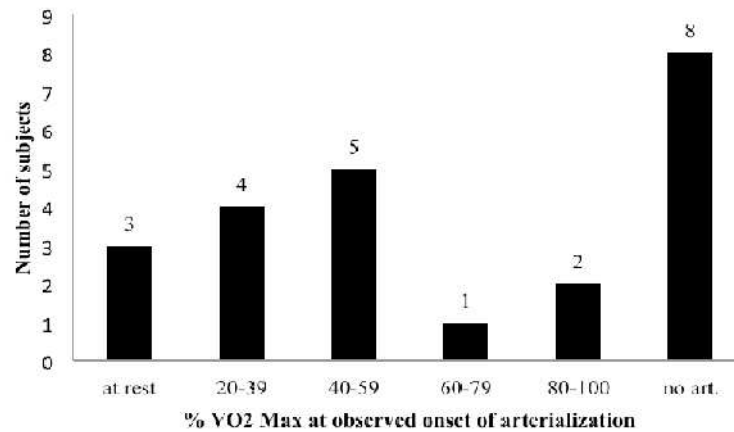

Fig. 10. %VO_{2max} during which arterialization was first observed.

Once arterialization was observed, and exercise suspended, the mean time until the left heart was clear of emboli was 88 ± 41 seconds. Exercise was then resumed at the same intensity that it was suspended. During the second round of exercise, supplemental O₂ (99.5%) was given once arterialization was observed and exercise was suspended. The %VO_{2max} that elicited arterialization in the second round was variable within individuals. However, the workload in watts at the time of the observed arterializations was equal in nine out of ten subjects who arterialized in both rounds of exercise. The mean time until the left heart was clear of emboli was 46 ± 15 s. Subjects 4 and 6 did not produce any observable emboli in the left heart during the second round of exercise.

2.4 Discussion

The purpose of this research was to examine how exercise before and after diving impacts physiological parameters associated with decompression stress and DCS. Secondary to those goals, analysis techniques were used to look beyond VGE alone as a marker for stress after diving. These studies provide novel information on the interaction of exercise and SCUBA diving and why timing is important.

SCUBA diving presents a unique challenge to homeostasis and serves as an excellent model for environmental stress on a variety of physiological parameters with implications in diverse populations. The diving community is expanding to include much larger, diverse, and at-risk participants. The study of exercise as a preconditioning countermeasure or as a risk factor in healthy subjects is the first step towards the expansion of diving protocols and procedures best suited for these populations. Finally, diving does not occur in an isolated instance; health and nutrition status, exercise, and stresses from other sources all combine with the stress of the dive itself to challenge the participant.

Exercise before diving

Although exercise before diving does not seem like a common scenario, the case may be more common in military divers; especially during times of training and indoctrination into special warfare communities. Exercise per se is not the only way to increase the workload on an individual. It is possible that some may open IPAVAs at such a low intensity that even some of the more stressful activities of daily living may be enough to trigger their opening.

Prior to beginning the first study three protocols were tested to determine their MP response. In addition to the following two selected for the studies an aerobic interval cycling test, similar to the selected treadmill routine, was trialed as well. The aerobic intervals consisted of a 20 minute warm up followed by eight, three minute intervals at 90% VO_{2max} each followed by active recovery. The HIT protocol consisted of the repeated Wingate protocol; four 30 second maximal effort cycling intervals each followed by four minutes of active recovery. When comparing a dive preceded by exercise to a control dive the following general observations can be made for both the aerobic interval and high intensity training (HIT) studies (studies 1 and 2): 1) No change in median VGE, following the exercise dive compared to the control dive; 2) Smaller increases in platelet counts at all time measurements; 3) Increased leukocyte counts pre diving; 4) Fewer circulating MPs; 5) A smaller increase in CD41 and CD66b-positive MPs; 6) evidence of platelet

activation pre-diving but less activation post-diving, and; 7) less evidence of platelet-neutrophil interactions.

The two different modes of exercise were selected in an attempt to eliminate certain variables related to longer duration exercise, such as dehydration through sweat loss, resulting in alterations in cardiac parameters. These alterations are the basis of one hypothesis on why exercise before diving may be beneficial (3). Additionally, high intensity exercise (HIT) has been shown to be as effective as aerobic training in certain outcomes such as increases in mitochondrial density (13) contributing towards an increase in VO₂max (28). Shorter HIT protocols on a stationary bicycle are more practical to implement and cycling does not require the skill that HIT on a treadmill requires.

Exercise itself results in increased MPs (11, 50, 53) which we also observed in the pilot studies (47). The above results are contrary to the initial hypothesis: paradoxically, exercise which leads to an increase in MPs, results in fewer MPs after diving which itself has been shown to increase MPs, suggesting potential protective effect.

It is unclear whether reductions in MP counts following dives preceded by exercise compared to control dives are related to an increased rate of uptake or a decrease in MP production. Currently, little is known about MP clearance and elimination. Phagocytosis is believed to be the primary means of MP clearance as has been demonstrated by Distler et al in vitro (16). It is believed that this is a result of the interaction between MP surface expression of phosphatidylserine and splenic macrophages. An alternative clearance pathway consisting of MP binding via surface expression of Del-1 was associated with the ability for endothelial cells to internalize MPs, describing a potentially more widespread clearance from vascular beds (15). This implies a complex relationship between exercise, diving, and endothelial function worth further investigation. Intense exercise can stimulate an acute increase of circulating leukocytes followed by a decrease as they move from the blood to the periphery in preparation to support a “fight or flight” response (68). It is possible that sympathetic activation associated with this immune response could be responsible for increased uptake and destruction of MPs: our data show a significantly increased leukocyte count before and 15 minutes after diving in the exercise group compared to the control group. Regardless of the mechanism, more research is needed to determine if the reduction in MPs and concomitant diminution in neutrophil activation associated

with exercise are related to the protective effect of exercise which has been shown to reduce the incidence of DCS in mice.

Platelet and neutrophil activation and interactions are associated with DCS in mice. Platelet derived MPs play a key role in neutrophil activation (62) and the reduction following the exercise before diving protocols could be related to a reduction in neutrophil activation observable as a decreased CD66b and MPO expression. A decrease in CD66b expressing MPs was also associated with a decrease in vascular injuries in mice (62) although further investigation is needed to determine if these risks are present and subsequently ameliorated by exercise before open water diving in humans. Recall that measures taken to prevent these changes and minimize MP production and expansion resulted in decreased rates of death and DCS symptoms (62), measured as damage to the brain, omentum, and soleus muscle.

The pattern of MP expression is not as clear following repetitive dives, defined in this thesis as two sets of three dives in three days. However, there was an unexpected yet intriguing result. Both groups experienced a significant decrease of all MP measurements in the second series of dives compared to the first, regardless of the placement of exercise. At this time there is not enough information to determine if this is related to an exhaustion and suppression of MP release or an increased clearance. The final measurement was significantly lower than the initial pre dive measurement, which had taken place before any exercise or diving, in both groups of the study ($p=0.001$ and 0.008 respectively).

The benefits on MP counts and neutrophil activation were observed in dives preceded by exercise despite no significant change in median bubble grades between the exercise and control dive procedures. These data are contrary to previous studies where exercise pre-diving was found to result in a clear reduction in post-dive bubbles (4, 10, 19, 22, 29). There are many factors that influence VGE production outside of exercise including fatigue, environmental conditions, and more recently, acclimatization to repeated bouts of SCUBA diving (2). It is possible that any one of these could have overshadowed any potential changes in VGE activity resulting from the exercise intervention. Finally, changes in environmental conditions such as temperature, timing in the dive season, and individual response to decompression stress could also impact the VGE loads. While measures can be taken to mitigate these variables, human trials cannot be controlled to the degree that animal or in vitro studies can.

Exercise after diving

The results of study 4 show that subjects who were not arterializing at rest after SCUBA diving experienced arterialization during exercise on a cycle ergometer. Although the subjects were seated in an upright position during exercise it is unlikely that the posture change alone was responsible for arterialization since subjects were observed in both the seated and supine positions at rest. Ljubkovic et al. (43) detailed the conditions necessary to provoke arterialization of VGE after diving at rest. One of these conditions was a bubble grade of at least 4B in the right heart. We have shown that, with post-dive exercise, divers can arterialize with a bubble score as low as 3.

The timing of exercise after diving may impact arterialization since divers typically reach peak bubble production 30 to 60 min after surfacing. It is thus possible that timing of exercise could be the difference between arterialization or not. However, in this study there was no significant difference in the exercise start time between those who did and those who did not arterialize. Rather, there was a significant difference in the initial bubble score, both supine and seated, which may contribute to arterialization during exercise. It is possible that there is still a minimal bubble score required to arterialize, even if open IPAVA during exercise provide a pathway. In this experiment, the only way to visualize the shunts was observation of emboli in the left heart. Bubble grades of 1 and 2 mean that emboli are not present in every cardiac cycle. Therefore, IPAVAs may be open, but the emboli used to observe this crossover may not be in high enough quantity to visualize through TTE.

In this study, administration of 100% oxygen upon detection of gas bubbles in the left heart, both resting and immediately after exercise, caused rapid cessation of arterialization in all tested individuals. Furthermore, the use of oxygen terminated arterialization quite rapidly (60-90 seconds of oxygen breathing) compared to breathing room air. It is believed that this is related to the mechanism of closing IPAVA with the application of oxygen. One proposed alternative is that this decrease in arterialization is related to an increased rate of nitrogen elimination, seen as a reduction of bubble load in the right heart. Oxygen pre-breathing is used in high altitude flights and astronaut extra-vehicular activity (EVA) to eliminate nitrogen from the blood via an increased concentration gradient and this principle has also been applied to SCUBA diving (7). This de-nucleation protocol can last between one and four hours for high altitude excursions (70). Exercise can speed this process up by increasing cardiac output and blood flow though the

pulmonary circuit, although even the shortened protocols studied last at least 15 minutes (69). Due to the rapid cessation of arterialization (mean time of 46 seconds) and the relatively low duration of oxygen administration, the time frame matches up more closely with other exercise and IPAVA studies rather than nitrogen washout. Additionally, our subgroup of six divers breathing oxygen shows that while oxygen did reduce VGE in divers at rest, this reduction was not significant until 16 minutes into the administration procedure. However, we cannot completely rule out the possibility that breathing 100% O₂, leading to an increased concentration gradient for nitrogen elimination at the alveolocapillary membrane, may still reduce the amount of bubbles in the pulmonary microcirculation.

This study also demonstrated that the use of supplemental O₂ can stop arterialization after SCUBA diving. The use of oxygen significantly decreased the time for emboli to leave the left heart compared to breathing room air. With only three subjects arterializing at rest, statistical conclusion are of little use, however in this study the difference in the time to stop arterializing with oxygen versus room air was noticeable. In both the case of rest and exercise, once the subject was taken off the oxygen, arterialization resumed after a relatively short amount of time. Without the use of supplemental oxygen, the half life of the bubble scores and arterialization at rest followed closely with previously observed results with similar dive profiles (60). The mean time for the reduction of the bubble grade to 0 in the left heart occurred at 45:05 minutes after surfacing accompanied by a concurrent decrease in VGE in the right cardiac chambers. For the subjects who shunted with exercise, while oxygen did decrease the time to clear emboli from the left heart, for practical purposes, removing the exercise stimulus also stopped arterialization within a few minutes.

As previously mentioned, VGE that cross over to the arterial circulation are considered more dangerous (67) than when they remain in the venous circulation. The common path of VGE takes them from the site where they were formed in the veins, through the right heart, and on to the pulmonary circuit for elimination. Bubbles that make it to the arterial side have opportunities to enter other tissues or block arterioles. If these bubbles interact with specific areas, such as brain and nervous tissues or joint capsules, they may directly lead to clinical signs and symptoms of DCS.

The patent foramen ovale (PFO) is one of the more commonly known means for emboli to crossover to the arterial side (34, 40, 58, 64, 67). As a brief review, the PFO is a congenital defect

where the opening between the two atria has failed to completely seal. Rather than thinking of it as a hole in the wall, a more accurate visual would be a closed door that can open under specific circumstances.

The acute and chronic consequences of arterialized emboli are still under investigation. While studies of long-term cognitive function show no impairment from injury free SCUBA diving (36) other studies showing brain lesions in sport divers warrant further investigation into the subject (33). It seems clear that divers with a right-to-left shunt, whether PFO or IPAVA, are at a higher risk than those without (33, 34, 40).

2.5 Conclusions

A single bout of exercise two hours before diving reduces MP counts and some indicators of platelet and neutrophil activation which are correlated with DCS in mice. The effect was observed following both aerobic interval training and anaerobic cycling. The effects get more complicated when this pattern is repeated daily. Over a series of repeated dives MP counts continued to rise. Following a rest period and a second series of dives, absolute MP counts were lower compared to the first series.

Exercise after diving increases the incidence of arterial gas embolism. While the overall risk of DCS remains low, evidence suggests arterialization likely increases relative risk of neurological DCS. Studies on career divers show some evidence of brain damage, however, there is no link to a decrease in cognitive performance and the rate of arterialization in these subjects is not known. Further research on the chronic effects of frequent arterialization is needed to completely determine the risk of IPAVAs and PFO. Exercise after diving is not limited to exercise per se, but physical activities associated with diving such as carrying heavy equipment and surface swimming in full kit could be enough to open IPAVAs. Populations with specific types of risk, such as stroke or increased thrombi production may be at an increased risk compared to healthy populations.

2.6 Summary

The aim of this dissertation was to examine the interactions between exercise before and SCUBA diving. The impact was determined on variables beyond VGE, which traditionally have served as a surrogate marker for decompression stress, but alone are a poor indicator of DCS risk. Four dive studies were conducted for this investigation, three on exercise before diving and one on exercise after diving. In addition to VGE, outcomes to assess decompression stress included arterialization of gas bubbles; changes in circulating MP counts, MP subtype expression associated with the inflammatory response, platelet counts and activation, and endothelial function.

Exercise before diving was already considered by some to be a protective form of preconditioning, however, this conclusion was primarily based on VGE analysis. These studies demonstrate a mitigation of MP counts and platelet-neutrophil activation and interaction that is associated with protective benefits in the murine model, providing additional information on the mechanism beyond VGE analysis. This effect was observed with both aerobic running and anaerobic cycling and was more pronounced following the running.

Exercise after diving led to an increased incidence of arterialization compared to resting conditions. Arterialization during exercise was preventable with concurrent 100% O₂ breathing and, arterialization while breathing atmospheric air ceased almost immediately after exercise was terminated. This may also demonstrate one of the mechanisms responsible for the positive outcomes associated with O₂ breathing as a first aid treatment for DCS. The intensity at which this arterialization occurred is variable with each individual. In some individuals the simple task of surface swimming or carrying equipment after a dive may be intense enough to cross the arterialization threshold.

From this study it was demonstrated that exercise after diving can provoke arterialization, which is associated with an increased relative risk of DCS. Exercise timed two hours before diving does not seem to impact VGE to a significant degree, however, it mitigates MP counts and certain indicators of the inflammatory process which are correlated with DCS in mice. MPs are also believed to contribute to the pathogenic process of certain diseases. Some of these findings may be useful immediately; those related to exercise after diving. Other findings provide more information towards uncovering an accurate understanding of the pathogenesis of DCS as well as mechanisms that may help protect against it.

2.7 Summary in Croatian

Cilj ovog istraživanja bio je ispitati povezanost tjeleovježbe i SCUBA ronjenja. Ispitan je utjecaj na mnoge parametre pored venske plinske embolije (venous gas emboli, VGE), koji je tradicionalno služio kao marker dekompresijskog stresa, no sam je nedovoljan indikator procjene rizika od dekompresijske bolesti. U ovom istraživanju provedena su četiri eksperimenta, tri s tjeleovježbom prije i jedan poslije ronjenja. Za procjenu dekompresijskog stresa, uz VGE, određeni su arterijalizacija mjehurića, promjene broja cirkulirajućih mikročestica, prisutnost različitih podtipova mikročestica povezanih s upalnom reakcijom, broj i aktivacija trombocita i endotelna funkcija.

Neki autori su smatrali tjeleovježbu prije zarona nekom vrstom protektivnog prekondicioniranja, no takvo mišljenje je prvenstveno utemeljeno na analizi VGE. Ove studije ukazuju na smanjenje broja mikročestica i njihovu aktivaciju te interakciju trombocita i neutrofila, što se povezuje sa zaštitnim učincima na mišjem modelu, dajući nove informacije o mehanizmima, uz samo određivanja VGE. Ovi utjecaji su bili prisutni i kod aerobnog trčanja i kod anaerobne vožnje bicikla, no bili su izraženiji poslije trčanja.

Tjeleovježba poslije ronjenja dovela je do povećanja učestalosti arterijalizacije u odnosu na stanje u mirovanju. Arterijalizacija tijekom tjeleovježbe se mogla spriječiti sa udisanjem 100% O₂, a arterijalizacija koja je bila prisutna tijekom udisanja atmosferskog zraka nestala je odmah nakon prekida tjeleovježbe. Ovo ujedno može ukazati i na mehanizme koji su odgovorni za pozitivan ishod povezan sa udisanjem O₂ kao prve pomoći u terapiji dekompresijske bolesti. Kod nekih pojedinaca, plivanje na površini i nošenje opreme nakon ronjenja može predstavljati dovoljno intenzivnu tjeleovježbu kojom će se dosegnuti prag za arterijalizaciju.

Ova studija je pokazala da tjeleovježba poslije ronjenja može izazvati arterijalizaciju, što je povezano s povećanjem relativnog rizika za razvoj dekompresijske bolesti. Tjeleovježba dva sata prije ronjenja ne utječe značajno na broj VGE, ali smanjuje broj mikročestica i pojedinih indikatora upalnog procesa koji su povezani s dekompresijskom bolešću kod miševa. Mikročestice su također povezane sa patogeneom nekih bolesti. Neki od ovih rezultata mogu biti već sada od koristi; oni u vezi s tjeleovježbom poslije ronjenja. Drugi nalazi pak mogu pridonijeti otkrivanju i točnom razumijevanju patogeneze dekompresijske bolesti kao i mehanizama kojima je možemo spriječiti.

2.8 Curriculum vitae

Dennis Madden MSc
Academic curriculum vitae
dmadden@mefst.hr

Education

- University of Split School of Medicine, 2012 – present, PhD candidate
- St Cloud State University, 2009 – 2011, Master of Science: Exercise Physiology
Thesis: High Intensity Interval Training and 40 km Cycling Time Trial
- The Ohio State University, 2005 – 2009, Bachelor of Science: Medical Dietetics, minor in Exercise Science

Certificates and additional training

- Hyperbaric tender course, Dec 2013 (5 days), Sharm-el-Sheikh, Egypt
- Registered Dietitian, Aug 2009 – present

Peer-reviewed publications

- Willie C, Ainslie P, Drvis I, MacLeod D, Bain A, **Madden D**, Zubin Maslov P, Dujic Z. Regulation of brain blood flow and oxygen delivery in elite breath-hold divers. *J Cereb Blood Flow Metab.* 2014 Nov [Epub ahead of print].
- **Madden D**, Barak O, Thom SR, Yang M, Bhopale VM, Ljubkovic M, Dujic Z. The impact of pre-dive exercise on repetitive SCUBA diving. *Clin Physiol Funct Imaging.* 2014 Oct [In press].
- **Madden D**, Ljubkovic M, Dujic Z. Intra-pulmonary shunt and SCUBA diving: Another risk factor? *Echocardiography.* 2014 Sep [In press]
- **Madden D**, Thom SR, Yang M, Bhopale VM, Ljubkovic M, Dujic Z. High intensity cycling before SCUBA diving reduces post-decompression microparticle production and neutrophil activation. *Eur J Appl Physiol.* 2014 Jun; 114(9): 1955-61
- Lozo M, Lojpur M, **Madden D**, Lozo P, Banic I, Dujic Z. The effects of nitroglycerin, norepinephrine and aminophylline on intrapulmonary arteriovenous anastomoses in healthy humans at rest. *Respir Physiol Neurobiol.* 2014 Aug 1;199:19-23
- **Madden D**, Thom SR, Milovanova TN, Yang M, Bhopale VM, Ljubkovic M, Dujic Z. Exercise before SCUBA Diving Ameliorates Decompression-Induced Neutrophil Activation. *Med Sci Sports Exerc.* 2014 Sep; 46(10): 1928-35

- Lozo M, **Madden D**, Gunjaca G, Ljubkovic M, Marinovic J, Dujic Z. The impact of consecutive freshwater trimix dives at altitude on human cardiovascular function. *Clin Physiol Funct Imaging*. 2014 Feb 16
- Sieber A, Schuster A, Reif S, **Madden D**, Enoksson P. Head-up display system for closed circuit rebreathers with antimagnetic wireless data transmission. *Marine Technology Society Journal*. 2013 Dec; 47(6):42-51
- **Madden D**, Lozo M, Dujic Z, Ljubkovic M. Exercise after SCUBA diving increases the incidence of arterial gas embolism. *J Appl Physiol* (1985). 2013 Sep 1;115(5):716-22
- Thom SR, Milovanova TN, Bogush M, Yang M, Bhopale VM, Pollock NW, Ljubkovic M, Denoble P, **Madden D**, Lozo M, Dujic Z. Bubbles, microparticles, and neutrophil activation: changes with exercise level and breathing gas during open-water SCUBA diving. *J Appl Physiol* (1985). 2013 May 15;114(10):1396-405

Peer-reviewed conferences

- Thom S, **Madden D**. 40th Annual Scientific Meeting of the European Undersea and Baromedical Society annual scientific meeting, Wiesbaden, Germany. 23-27/09/2014 (oral presentation).
- Buzzacott P, Schuster A, Gerges A, Hemelryck W, Lambrechts K, **Madden D**, Papadopoulou V, Tkachenko Y, Mazur A, Tillmans F, Rozloznik M, Wang Q, Mollerlokken A, Guerrero F, Sieber A. A new model of head-up display dive computer addressing safety-critical rate of ascent and returning gas pressure: a pilot trial. *European Undersea and Baromedical Society annual scientific meeting*, Wiesbaden, Germany. 23-27/09/2014 (poster presentation)
- **Madden D**. The impact of exercise on repetitive diving. 3rd International Congress of the Croatian Physiological Society, Split, Croatia. Sep 2014. (oral presentation)
- **Madden D**. Exercise after diving and arterial gas embolism. 39th Annual Scientific Meeting of the European Underwater and Barometric Society, Reunion, Sep 2013 (oral presentation).
- **Madden D**. Exercise before SCUBA diving. 2nd International Congress of the Croatian Physiological Society, Rijeka, Croatia. Sep 2013. (oral presentation)
- **Madden D**. The interaction of exercise and diving. 1st International Congress of the Croatian Physiological Society, Zagreb, Croatia. Sep 2012. (oral presentation)
- **Madden D**, Wright E, Street G. Design and calibration of an arm ergometer for Nordic skiers. 57th Annual Meeting of the American College of Sports Medicine. Baltimore, Maryland June 2010 (poster).

2.9 References

1. Anderson HC, Mulhall D, and Garimella R. Role of extracellular membrane vesicles in the pathogenesis of various diseases, including cancer, renal diseases, atherosclerosis, and arthritis. *Laboratory investigation; a journal of technical methods and pathology* 90: 1549-1557, 2010.
2. Bilopavlovic N, Marinovic J, Ljubkovic M, Obad A, Zanchi J, Pollock NW, Denoble P, and Dujic Z. Effect of repetitive SCUBA diving on humoral markers of endothelial and central nervous system integrity. *European journal of applied physiology* 113: 1737-1743, 2013.
3. Blatteau JE, Boussuges A, Gempp E, Pontier JM, Castagna O, Robinet C, Galland FM, and Bourdon L. Haemodynamic changes induced by submaximal exercise before a dive and its consequences on bubble formation. *British journal of sports medicine* 41: 375-379, 2007.
4. Blatteau JE, Gempp E, Galland FM, Pontier JM, Sainty JM, and Robinet C. Aerobic exercise 2 hours before a dive to 30 msw decreases bubble formation after decompression. *Aviation, space, and environmental medicine* 76: 666-669, 2005.
5. Blatteau JE, Peny C, Pontier JM, Gempp E, and Louge P. Influence of repetitive open sea dives and physical exercises on right-to-left shunting in healthy divers. *British journal of sports medicine* 42: 934-936, 2008.
6. Bonomo M, Cairoli R, Verde G, Morelli L, Moreo A, Grottaglie MD, Brambilla MC, Meneghini E, Aghemo P, Corigliano G, and Marroni A. Safety of recreational scuba diving in type 1 diabetic patients: the Deep Monitoring programme. *Diabetes & metabolism* 35: 101-107, 2009.
7. Bosco G, Yang ZJ, Di Tano G, Camporesi EM, Faralli F, Savini F, Landolfi A, Doria C, and Fano G. Effect of in-water oxygen prebreathing at different depths on decompression-induced bubble formation and platelet activation. *J Appl Physiol* 108: 1077-1083, 2010.
8. Bove AA. The cardiovascular system and diving risk. *Undersea & hyperbaric medicine : journal of the Undersea and Hyperbaric Medical Society, Inc* 38: 261-269, 2011.
9. Brubakk AO, Duplancic D, Valic Z, Palada I, Obad A, Bakovic D, Wisloff U, and Dujic Z. A single air dive reduces arterial endothelial function in man. *The Journal of physiology* 566: 901-906, 2005.

10. Castagna O, Brisswalter J, Vallee N, and Blatteau JE. Endurance exercise immediately before sea diving reduces bubble formation in scuba divers. *European journal of applied physiology* 111: 1047-1054, 2011.
11. Chaar V, Romana M, Tripette J, Broquere C, Huisse MG, Hue O, Hardy-Dessources MD, and Connes P. Effect of strenuous physical exercise on circulating cell-derived microparticles. *Clinical hemorheology and microcirculation* 47: 15-25, 2011.
12. Christmas BC, Midgley AW, Taylor L, Vince RV, Laden G, and Madden LA. Acute antioxidant pre-treatment attenuates endothelial microparticle release after decompression. *Diving and hyperbaric medicine : the journal of the South Pacific Underwater Medicine Society* 40: 184-188, 2010.
13. Cocks M, Shaw CS, Shepherd SO, Fisher JP, Ranasinghe AM, Barker TA, Tipton KD, and Wagenmakers AJ. Sprint interval and endurance training are equally effective in increasing muscle microvascular density and eNOS content in sedentary males. *The Journal of physiology* 591: 641-656, 2013.
14. Connor DE, Exner T, Ma DD, and Joseph JE. The majority of circulating platelet-derived microparticles fail to bind annexin V, lack phospholipid-dependent procoagulant activity and demonstrate greater expression of glycoprotein Ib. *Thrombosis and haemostasis* 103: 1044-1052, 2010.
15. Dasgupta SK, Le A, Chavakis T, Rumbaut RE, and Thiagarajan P. Developmental endothelial locus-1 (Del-1) mediates clearance of platelet microparticles by the endothelium. *Circulation* 125: 1664-1672, 2012.
16. Distler JH, Akhmetshina A, Dees C, Jungel A, Sturzl M, Gay S, Pisetsky DS, Schett G, and Distler O. Induction of apoptosis in circulating angiogenic cells by microparticles. *Arthritis and rheumatism* 63: 2067-2077, 2011.
17. Doll RE. Decompression Sickness among U.S. Navy Operational Divers: An Estimate of Incidence Using Air Decompression Tables. Res Rep 4-64. *Report United States Navy Experimental Diving Unit, Washington, D C* 1-10, 1965.
18. Doyen D, Castellani M, Mocerì P, Chiche O, Lazdunski R, Bertora D, Cerboni P, Chaussade C, and Ferrari E. Patent foramen ovale and stroke in intermediate-risk pulmonary embolism. *Chest* 2014.

19. Dujic Z, Duplancic D, Marinovic-Terzic I, Bakovic D, Ivancev V, Valic Z, Eterovic D, Petri NM, Wisloff U, and Brubakk AO. Aerobic exercise before diving reduces venous gas bubble formation in humans. *The Journal of physiology* 555: 637-642, 2004.
20. Dujic Z, Obad A, Palada I, Ivancev V, and Valic Z. Venous bubble count declines during strenuous exercise after an open sea dive to 30 m. *Aviation, space, and environmental medicine* 77: 592-596, 2006.
21. Dujic Z, Palada I, Obad A, Duplancic D, Bakovic D, and Valic Z. Exercise during a 3-min decompression stop reduces postdive venous gas bubbles. *Medicine and science in sports and exercise* 37: 1319-1323, 2005.
22. Dujic Z, Valic Z, and Brubakk AO. Beneficial role of exercise on scuba diving. *Exercise and sport sciences reviews* 36: 38-42, 2008.
23. Eckenhoff RG, Olstad CS, and Carrod G. Human dose-response relationship for decompression and endogenous bubble formation. *J Appl Physiol (1985)* 69: 914-918, 1990.
24. Eftedal O, and Brubakk AO. Agreement between trained and untrained observers in grading intravascular bubble signals in ultrasonic images. *Undersea & hyperbaric medicine : journal of the Undersea and Hyperbaric Medical Society, Inc* 24: 293-299, 1997.
25. Eftedal OS, Lydersen S, and Brubakk AO. The relationship between venous gas bubbles and adverse effects of decompression after air dives. *Undersea & hyperbaric medicine : journal of the Undersea and Hyperbaric Medical Society, Inc* 34: 99-105, 2007.
26. Eldridge MW, Dempsey JA, Haverkamp HC, Lovering AT, and Hokanson JS. Exercise-induced intrapulmonary arteriovenous shunting in healthy humans. *J Appl Physiol* 97: 797-805, 2004.
27. Enjeti AK, Lincz LF, and Seldon M. Microparticles in health and disease. *Seminars in thrombosis and hemostasis* 34: 683-691, 2008.
28. Enoksen E, Shalfawi SA, and Tonnessen E. The effect of high- vs. low-intensity training on aerobic capacity in well-trained male middle-distance runners. *Journal of strength and conditioning research / National Strength & Conditioning Association* 25: 812-818, 2011.
29. Gempp E, and Blatteau JE. Preconditioning methods and mechanisms for preventing the risk of decompression sickness in scuba divers: a review. *Research in sports medicine* 18: 205-218, 2010.

30. Gempp E, Louge P, Blatteau JE, and Hugon M. Risks factors for recurrent neurological decompression sickness in recreational divers: a case-control study. *The Journal of sports medicine and physical fitness* 52: 530-536, 2012.
31. Gempp E, Louge P, Henckes A, Demaistre S, Heno P, and Blatteau JE. Reversible myocardial dysfunction and clinical outcome in scuba divers with immersion pulmonary edema. *The American journal of cardiology* 111: 1655-1659, 2013.
32. Gennser M, Jurd KM, and Blogg SL. Pre-dive exercise and post-dive evolution of venous gas emboli. *Aviation, space, and environmental medicine* 83: 30-34, 2012.
33. Gerriets T, Tetzlaff K, Hutzelmann A, Liceni T, Kopsiske G, Struck N, Reuter M, and Kaps M. Association between right-to-left shunts and brain lesions in sport divers. *Aviation, space, and environmental medicine* 74: 1058-1060, 2003.
34. Gerriets T, Tetzlaff K, Liceni T, Schafer C, Rosengarten B, Kopsiske G, Algermissen C, Struck N, and Kaps M. Arteriovenous bubbles following cold water sport dives: relation to right-to-left shunting. *Neurology* 55: 1741-1743, 2000.
35. Harrison D, Lloyd-Smith R, Khazei A, Hunte G, and Lepawsky M. Controversies in the medical clearance of recreational scuba divers: updates on asthma, diabetes mellitus, coronary artery disease, and patent foramen ovale. *Current sports medicine reports* 4: 275-281, 2005.
36. Hemelryck W, Germonpre P, Papadopoulou V, Rozloznik M, and Balestra C. Long term effects of recreational SCUBA diving on higher cognitive function. *Scandinavian journal of medicine & science in sports* 2013.
37. Hills BA, and Butler BD. Size distribution of intravascular air emboli produced by decompression. *Undersea biomedical research* 8: 163-170, 1981.
38. James T, Francis R, and Mitchel S. Pathophysiology of Decompression Sickness. In: *Physiology and Medicine of Diving*, edited by Brubakk AO, and Neuman T. Edinburgh: Saunders, 2003, p. 530-556
39. Kennedy JM, Foster GE, Koehle MS, Potts JE, Sandor GG, Potts MT, Houghton KM, Henderson WR, and Sheel AW. Exercise-induced intrapulmonary arteriovenous shunt in healthy women. *Respiratory physiology & neurobiology* 181: 8-13, 2012.
40. Knauth M, Ries S, Pohimann S, Kerby T, Forsting M, Daffertshofer M, Hennerici M, and Sartor K. Cohort study of multiple brain lesions in sport divers: role of a patent foramen ovale. *Bmj* 314: 701-705, 1997.

41. Ljubkovic M, Dujic Z, Mollerlokken A, Bakovic D, Obad A, Breskovic T, and Brubakk AO. Venous and arterial bubbles at rest after no-decompression air dives. *Medicine and science in sports and exercise* 43: 990-995, 2011.
42. Ljubkovic M, Marinovic J, Obad A, Breskovic T, Gaustad SE, and Dujic Z. High incidence of venous and arterial gas emboli at rest after trimix diving without protocol violations. *J Appl Physiol* 109: 1670-1674, 2010.
43. Ljubkovic M, Zanchi J, Breskovic T, Marinovic J, Lojpur M, and Dujic Z. Determinants of arterial gas embolism after scuba diving. *J Appl Physiol (1985)* 112: 91-95, 2012.
44. Lovering AT, Romer LM, Haverkamp HC, Pegelow DF, Hokanson JS, and Eldridge MW. Intrapulmonary shunting and pulmonary gas exchange during normoxic and hypoxic exercise in healthy humans. *J Appl Physiol* 104: 1418-1425, 2008.
45. Lovering AT, Stickland MK, Amann M, Murphy JC, O'Brien MJ, Hokanson JS, and Eldridge MW. Hyperoxia prevents exercise-induced intrapulmonary arteriovenous shunt in healthy humans. *The Journal of physiology* 586: 4559-4565, 2008.
46. Lovering AT, Stickland MK, Kelso AJ, and Eldridge MW. Direct demonstration of 25- and 50-microm arteriovenous pathways in healthy human and baboon lungs. *American journal of physiology Heart and circulatory physiology* 292: H1777-1781, 2007.
47. Madden D, Thom SR, Milovanova TN, Yang M, Bhopale VM, Ljubkovic M, and Dujic Z. Exercise before SCUBA Diving Ameliorates Decompression-Induced Neutrophil Activation. *Medicine and science in sports and exercise* 2014.
48. Madden LA, Christmas BC, Mellor D, Vince RV, Midgley AW, McNaughton LR, Atkin SL, and Laden G. Endothelial function and stress response after simulated dives to 18 msw breathing air or oxygen. *Aviation, space, and environmental medicine* 81: 41-45, 2010.
49. Madden LA, and Laden G. Gas bubbles may not be the underlying cause of decompression illness - The at-depth endothelial dysfunction hypothesis. *Medical hypotheses* 72: 389-392, 2009.
50. Maruyama K, Kadono T, and Morishita E. Plasma levels of platelet-derived microparticles are increased after anaerobic exercise in healthy subjects. *Journal of atherosclerosis and thrombosis* 19: 585-587, 2012.
51. Mause SF, and Weber C. Microparticles: protagonists of a novel communication network for intercellular information exchange. *Circulation research* 107: 1047-1057, 2010.

52. Mazur A, Lambrechts K, Buzzacott P, Wang Q, Belhomme M, Theron M, Mansourati J, and Guerrero F. Influence of Decompression Sickness on Vasomotion of Isolated Rat Vessels. *International journal of sports medicine* 2013.
53. Mobius-Winkler S, Hilberg T, Menzel K, Golla E, Burman A, Schuler G, and Adams V. Time-dependent mobilization of circulating progenitor cells during strenuous exercise in healthy individuals. *Journal of applied physiology* 107: 1943-1950, 2009.
54. Mollerlokken A, Breskovic T, Palada I, Valic Z, Dujic Z, and Brubakk AO. Observation of increased venous gas emboli after wet dives compared to dry dives. *Diving and hyperbaric medicine : the journal of the South Pacific Underwater Medicine Society* 41: 124-128, 2011.
55. Obad A, Palada I, Ivancev V, Valic Z, Fabijanic D, Brubakk AO, and Dujic Z. Sonographic detection of intrapulmonary shunting of venous gas bubbles during exercise after diving in a professional diver. *Journal of clinical ultrasound : JCU* 35: 473-476, 2007.
56. Olszanski R, Radziwon P, Piszcz J, Jarzemowski J, Gosk P, Bujno M, and Schenk JF. Activation of platelets and fibrinolysis induced by saturated air dives. *Aviation, space, and environmental medicine* 81: 585-588, 2010.
57. Polovina MM, and Potpara TS. Endothelial dysfunction in metabolic and vascular disorders. *Postgraduate medicine* 126: 38-53, 2014.
58. Ries S, Knauth M, Kern R, Klingmann C, Daffertshofer M, Sartor K, and Hennerici M. Arterial gas embolism after decompression: correlation with right-to-left shunting. *Neurology* 52: 401-404, 1999.
59. Stickland MK, Welsh RC, Haykowsky MJ, Petersen SR, Anderson WD, Taylor DA, Bouffard M, and Jones RL. Intra-pulmonary shunt and pulmonary gas exchange during exercise in humans. *The Journal of physiology* 561: 321-329, 2004.
60. Thom SR, Milovanova TN, Bogush M, Bhopale VM, Yang M, Bushmann K, Pollock NW, Ljubkovic M, Denoble P, and Dujic Z. Microparticle production, neutrophil activation, and intravascular bubbles following open-water SCUBA diving. *Journal of applied physiology* 112: 1268-1278, 2012.
61. Thom SR, Milovanova TN, Bogush M, Yang M, Bhopale VM, Pollock NW, Ljubkovic M, Denoble PJ, Madden D, Lozo M, and Dujic Z. Bubbles, microparticles and neutrophil activation: changes with exercise level and breathing gas during open-water SCUBA diving. *Journal of applied physiology* 2013.

62. Thom SR, Yang M, Bhopale VM, Huang S, and Milovanova TN. Microparticles initiate decompression-induced neutrophil activation and subsequent vascular injuries. *Journal of applied physiology* 110: 340-351, 2011.
63. Thom SR, Yang M, Bhopale VM, Huang S, and Milovanova TN. Microparticles initiate decompression-induced neutrophil activation and subsequent vascular injuries. *J Appl Physiol (1985)* 110: 340-351, 2011.
64. Torti SR, Billinger M, Schwerzmann M, Vogel R, Zbinden R, Windecker S, and Seiler C. Risk of decompression illness among 230 divers in relation to the presence and size of patent foramen ovale. *European heart journal* 25: 1014-1020, 2004.
65. Tyldum GA, Schjerve IE, Tjonna AE, Kirkeby-Garstad I, Stolen TO, Richardson RS, and Wisloff U. Endothelial dysfunction induced by post-prandial lipemia: complete protection afforded by high-intensity aerobic interval exercise. *Journal of the American College of Cardiology* 53: 200-206, 2009.
66. van Velzen JF, Laros-van Gorkom BA, Pop GA, and van Heerde WL. Multicolor flow cytometry for evaluation of platelet surface antigens and activation markers. *Thrombosis research* 130: 92-98, 2012.
67. Vann RD, Butler FK, Mitchell SJ, and Moon RE. Decompression illness. *Lancet* 377: 153-164, 2011.
68. Walsh NP, Gleeson M, Pyne DB, Nieman DC, Dhabhar FS, Shephard RJ, Oliver SJ, Berman S, and Kajeniene A. Position statement. Part two: Maintaining immune health. *Exercise immunology review* 17: 64-103, 2011.
69. Webb JT, Fischer MD, Heaps CL, and Pilmanis AA. Exercise-enhanced preoxygenation increases protection from decompression sickness. *Aviation, space, and environmental medicine* 67: 618-624, 1996.
70. Webb JT, and Pilmanis AA. Preoxygenation time versus decompression sickness incidence. *Safe journal* 29: 75-78, 1999.
71. Wisloff U, and Brubakk AO. Aerobic endurance training reduces bubble formation and increases survival in rats exposed to hyperbaric pressure. *The Journal of physiology* 537: 607-611, 2001.

72. Yang M, Milovanova TN, Bogush M, Uzun G, Bhopale VM, and Thom SR. Microparticle enlargement and altered surface proteins after air decompression are associated with inflammatory vascular injuries. *J Appl Physiol (1985)* 112: 204-211, 2012.
73. Zanchi J, Ljubkovic M, Denoble PJ, Dujic Z, Ranapurwala S, and Pollock NW. Influence of Repeated Daily Diving on Decompression Stress. *International journal of sports medicine* 2013.

3.0 PAPERS

Exercise before Scuba Diving Ameliorates Decompression-Induced Neutrophil Activation

DENNIS MADDEN¹, STEPHEN R. THOM², TATYANA N. MILOVANOV³, MING YANG², VEENA M. BHOPALE², MARKO LJUBKOVIC¹, and ZELJKO DUJIC¹

¹Department of Physiology, School of Medicine, University of Split, Split, CROATIA; ²Department of Emergency Medicine, University of Maryland, Baltimore, MD; and ³Institute for Environmental Medicine, Perelman School of Medicine, University of Pennsylvania, Philadelphia, PA

ABSTRACT

MADDEN, D., S. R. THOM, T. N. MILOVANOV³, M. YANG, V. M. BHOPALE, M. LJUBKOVIC, and Z. DUJIC. Exercise before Scuba Diving Ameliorates Decompression-Induced Neutrophil Activation. *Med. Sci. Sports Exerc.*, Vol. 46, No. 10, pp. 1928–1935, 2014. **Introduction:** The goals of this study were to investigate the difference in responses between a scuba dive preceded by aerobic exercise (EX) and a nonexercise control dive (CON) and to further evaluate the potential relation between venous gas emboli (VGE) and microparticles (MP). We hypothesized that exercise would alter the quantity and subtype of annexin V-positive MP and VGE. **Methods:** Nineteen divers performed two dives to 18 m seawater for 41 min separated by at least 3 d, one of which was preceded by 60 min of treadmill interval exercise. Blood was obtained before exercise, before diving, and 15 min, 2 h, 4 h, and 24 h after surfacing. Intravascular bubbles were quantified by transthoracic echocardiography at 15, 40, 80, and 120 min. **Results:** The median VGE remained unchanged between the two dives; however, there was a significant increase in VGE in the exercise dive at 40 and 80 min at rest. MP were significantly elevated by approximately 2 times at all time points after CON compared with those after EX. Markers of neutrophil and platelet activation were elevated by both dives, and these elevations were attenuated in the EX dive. **Conclusions:** We conclude that some of the differences observed between the EX and CON related to MP and platelet and neutrophil activation provide additional insight into the potential protective benefits of exercise; however, further study is needed to understand the mechanism and true potential of these benefits. **Key Words:** DECOMPRESSION SICKNESS, INTRAVASCULAR BUBBLES, LEUKOCYTES, PLATELETS, EXERCISE

As a scuba diver ascends to the surface, inert gases, which were absorbed into the blood and tissue under high ambient pressure during the dive, are released into the blood as venous gas emboli (VGE) and have traditionally served as a quantifiable indicator for decompression stress. Recently, other methods have been investigated to measure additional parameters associated with decompression sickness (DCS) and stress, including platelet count (25), aggregation (22), and microparticles (MP) (24). MP are cell-derived vesicles containing a lipid bilayer, protein aggregates, and other debris with a diameter of 0.1–1.0 μm . MP are produced as a result of apoptosis, oxidative stress, or cellular activation/calcium influx (11,12,15). MP are present in the peripheral blood of healthy individuals; they increase with traumatic and inflammatory disorders and may serve as intercellular messengers because they can contain cytokines

or other signaling proteins, messenger RNA, and microRNA (19). MP are characterized by the surface expression of antigenic markers from parent cells, and many also have surface-bound annexin V because, as they are formed, negatively charged phosphatidylserine residues become exposed. Enlarged MP (1–3 μm), resulting from expansion of an inert gas core during decompression, have been shown to cause vascular injuries in mice (36), and it has been demonstrated that these MP provide a nucleation site for inert gas uptake (31) during decompression. Additional human studies showed an increase in size and number of MP after an open-water dive (29) and increased endothelial MP in a simulated dive (33). In addition to scuba diving, exercise has been shown to increase circulating MP for several hours after a single bout (5,18,27), and one study demonstrated a near return to baseline after 24 h (20).

The effect of exercise before diving on VGE measured postdiving was investigated in several studies. Some of these studies used simulated dry chamber dives (14), which may not accurately replicate the stress associated with open-water diving (21). Currently, exercise is considered by some to be a form of protective preconditioning for scuba diving (9,13,23), although these claims have been based on animal survival studies (35) or decreased VGE in humans after aerobic exercise. Proposed mechanisms include altered hemodynamics (2), increased nitric oxide concentration, and

Address for correspondence: Zeljko Dujic, M.D., Ph.D., Department of Physiology, School of Medicine, University of Split, Soltanska 2, 21000 Split, Croatia; E-mail: zeljko.dujic@mefst.hr.
Submitted for publication November 2013.
Accepted for publication February 2014.

0195-9131/14/4610-1928/0
MEDICINE & SCIENCE IN SPORTS & EXERCISE®
Copyright © 2014 by the American College of Sports Medicine
DOI: 10.1249/MSS.0000000000000319

improved vasoreactivity (9). Exercise protocols tested before diving varied in intensity from 60% age-predicted HR_{max} (3) to intervals at 90% HR_{max} (8), with running as the mode of exercise. Studies examined interactions of exercise with diving within 2 (2–4) or 24 h (8) before diving.

Because some forms of exercise have been shown to increase circulating MP and MP may be associated with increased decompression stress (36), exercise may affect the bubble load by producing an increased number of circulating cell fragments and micronuclei that may absorb inert gas upon decompression. To further test this hypothesis, in the current study, we had divers exercise (EX) before an open-water dive in conditions that would elicit MP responses lasting for at least 2 h and compared these results with those of a control dive (CON) under the same conditions but without exercise. Finally, in our previous studies with volunteers undergoing repetitive dives (28) or dives with two different breathing gas mixtures and two levels of exertion during dives (29), blood was collected only up to 2 h postdive. Therefore, this study was planned to assess associations between MP number and neutrophil activation up to 24 h postdive, in parallel to collected murine data.

MATERIALS AND METHODS

Study population. Nineteen divers including 14 males (age (mean \pm SD), 38 ± 6 yr) and five females (31 ± 8 yr) with 14.1 ± 9 yr of diving experience participated in this study. Maximal oxygen consumption ($\dot{V}O_{2max}$) for males was 36.5 ± 3.4 mL \cdot kg $^{-1}\cdot$ min $^{-1}$ and 36.1 ± 4.2 mL \cdot kg $^{-1}\cdot$ min $^{-1}$ for females. The mean body mass index for males was 27.4 ± 2.5 kg \cdot m $^{-2}$ and 22.5 ± 2.4 kg \cdot m $^{-2}$ for females. Divers were apparently healthy at the beginning of the study and were recently given clearance to dive by a physician. No subjects reported previous cases of DCS. After receiving a written explanation and an oral briefing of the methods and potential risks, all subjects gave their written informed consent. This study was approved by the University of Split School of Medicine ethics committee, and all procedures were conducted in accordance with the Declaration of Helsinki.

Exercise selection protocol. Testing was conducted on three different exercise protocols to monitor MP response. The goal was to compare a treadmill protocol, which has been proven to be beneficial to divers related to VGE production in a previous study (8), with a similar protocol performed on a cycle ergometer and an anaerobic protocol. Wingate cycling was chosen for the anaerobic trial because of the relative safety compared with that in equivalent anaerobic efforts performed on a treadmill. These trials were conducted 2 months before the beginning of the study to determine the exercise protocol that should be used before diving. Briefly, the following protocols were performed each with four subjects: 1) intervals on a bicycle ergometer consisting of 3 min at $\dot{V}O_{2max}$ power (W) and 1.5 min of active recovery, which were repeated until the subject could no longer maintain 90% of $\dot{V}O_{2max}$ power (cumulative

time, 15–18 min), 2) repeated Wingate tests on a bicycle ergometer consisting of 4×30 s of maximal efforts with 4 min of active recovery (cumulative time, 23 min including warm-up), and 3) treadmill intervals consisting of 3 min at a velocity that elicited 90% of HR_{max} determined by previous testing (explained in detail in the following section) and 2 min at 50% repeated eight times (cumulative time, 60 min). Treadmill interval exercise (protocol 3) was selected for this study for two reasons: it is the same protocol used in an earlier exercise and a simulated dive study (8) has shown the protocol to decrease VGE, and the MP response was more pronounced and prolonged compared with that in the cycling protocols (data not shown).

$\dot{V}O_{2max}$ testing. $\dot{V}O_{2max}$ and pulmonary function testing were performed on all divers at least 3 d before the diving experiment. Before testing, height, weight, and percent body fat for each subject were determined. Body density was estimated by measurement of subcutaneous skinfold thickness with a caliper (Harpenden skinfold caliper; Baly International, West Sussex, England) for the calculation of body composition. Pulmonary function assessment included forced vital capacity and maximal voluntary ventilation tests. The $\dot{V}O_{2max}$ test was an incremental test conducted on a treadmill (COSMED T165 sport; COSMED, Rome, Italy) beginning at 3 km \cdot h $^{-1}$ and 2% grade and increasing 1 km \cdot h $^{-1}$ every minute until voluntary termination or when at least two of the three following requirements were met: 1) a plateau of $\dot{V}O_2$ (<150 mL absolute increase) or HR with an increase in workload, 2) RER greater than 1.1, and 3) HR in excess of 90% of age-predicted ($220 - \text{age}$) maximal values. Once these criteria were met, the highest recorded $\dot{V}O_2$ was selected as the subject's maximal value.

Exercise protocol. Subjects completed a 20-min self-selected warm-up immediately followed by 40 min of intervals as described by protocol 3 of the pilot studies, for a total of 60 min of treadmill running. The treadmills were controlled by volunteers to allow the divers to focus on running and to ensure that the correct exercise prescription was delivered.

Dive and VGE analysis. This study was performed at a military installation of the Croatian Navy Force. The dive site was located near the base, within a short (approximately 30 m) distance from the location where the experiments would take place. The site was chosen because of the minimal transit time between finishing the dive and beginning initial transthoracic echocardiography analysis. All divers performed the dive at a depth of 18 m seawater with a bottom time of 41 min. This dive profile was selected with a dive planning software built into Galileo dive computers (Uwatec Galileo Sol; Johnson Outdoors, Inc., Racine, WI), which were also used to verify subject adherence to the dive protocol. Decompression was performed at a rate of 9 m seawater \cdot min $^{-1}$, with direct ascent to the surface. Sea temperature at the bottom was approximately 11°C, and the outside temperature was approximately 19°C. Throughout the dive, divers performed swimming of subjectively moderate intensity and HR was monitored via dive

computers. Within 8–15 min after surfacing, the divers were placed in the supine position where a dual-frequency (1.5–3.3 MHz) ultrasonic probe connected to a Vivid q echographic scanner (GE, Milwaukee, WI) was used to obtain a clear, apical, four-chamber view of the heart. VGE were monitored at 15, 40, 80, and 120 min after surfacing, and bubble scores were recorded and graded on a scale of 0–5, with 4 being subdivided into 4A, 4B, and 4C, according to the method described by Eftedal and Brubakk (10) and later modified by Ljubkovic et al. (17). In addition to monitoring scores at rest, VGE were graded after two different movements, arm and leg contractions, to mobilize bubbles that may be lodged in the venous circulation.

EX and CON dive protocols. Subjects were randomly selected to begin the CON or EX dive first, with at least 3 d between the dives. The divers performed 1 h of treadmill running beginning 3 h before descent. Upon surfacing, VGE were graded for 120 min after surfacing, as described previously. Blood for complete blood count (CBC) and MP analysis was drawn, as will be described in the next section. The CON dive was performed exactly as the EX dive, only without the exercise. Water was allowed *ad libitum* throughout the study, and a light meal was provided in between exercise and diving.

CBC analysis. Whole blood samples were obtained from the subjects before exercise (EX dive protocol only) approximately 30 min before diving and 15 min after surfacing. Blood was stored in a cooler and transported to the Department of Biochemistry, University Hospital Split, for analysis within 2 h of obtaining the sample. CBC values were measured with the Abbott Cell-Dyne 4000 cell counter (Abbott Laboratories, Abbott Park, IL).

MP chemicals and procedures. Venous blood was collected by a trained phlebotomist 30 min before and at 15 min, 2 h, 4 h, and 24 h after the dives. Blood was drawn into Cyto-Chex BCT test tubes that contain a proprietary preservative (Streck, Inc., Mediamark Europe, Grenoble, France). The volume drawn per sample (two tubes) was approximately 5 mL.

Materials. Unless otherwise noted, chemicals were purchased from Sigma-Aldrich (St. Louis, MO). Annexin binding buffer and the following antibodies were purchased from BD Pharmingen (San Jose, CA): fluorescein isothiocyanate-conjugated anti-annexin V and fluorescein isothiocyanate-conjugated anti-human myeloperoxidase (MPO). R-phycoerythrin-conjugated anti-human CD41 was purchased from eBioscience (San Diego, CA); PerCP Cy5.5-conjugated anti-human CD66b from BioLegend (San Diego, CA) and Alexa 647-conjugated anti-human CD18 were purchased from AbD Serotec (Raleigh, NC).

Standard procedures for MP and neutrophil acquisition and processing. Blood samples in tubes containing a preservative were sent by express mail to the University of Pennsylvania where all analyses were performed within 24 h after arrival, approximately 2–6 d from the time of collection. As described previously, MP and neutrophil characteristics remain unchanged when samples stored at either 4°C or at room temperature are processed in a

time span of 3 wk from the time of collection (16). All reagents and solutions used for MP analysis were sterile and filtered (0.2- μ m filter). The blood was centrifuged for 5 min at 1500g; the supernatant EDTA was made at a concentration of 0.2 M and then centrifuged at 15,000g for 30 min. Aliquots of the 15,000g supernatant were stained with antibodies for analysis by flow cytometry and confocal microscopy.

Flow cytometry. Flow cytometry was performed with a 10-color FACSCanto (Becton Dickinson, San Jose, CA) using a standard acquisition software. Gates were set to include 0.3- to 5.0- μ m particles, with exclusion of background corresponding to debris usually present in buffers. MP were stained with annexin V antibody and were analyzed as previously described, including microbeads with diameters of 0.3 μ m (Sigma, Inc.), 1.0 μ m, 3.0 μ m, and 5 μ m (Spherotech, Inc., Lake Forest, IL) to assess the size of particles. We define MP as annexin V-positive particles with diameters up to 1 μ m and enlarged MP as those between 1 and 3 μ m. Analysis of neutrophils was performed on fixed blood samples, as previously described (30). Platelet activation was assessed by staining samples with CD41 and annexin V antibodies in samples that included microbeads with diameters of 3 and 5 μ m. Platelets were identified as particles between these microbead size limits that were CD41-positive and annexin V-negative, and activation was assessed as surface expression of CD63 and CD62b, analogous to procedures described by others (32).

Statistics. Parametric data are expressed as mean \pm SD, and nonparametric data are expressed as median and 25th and 75th percentile. MP counts and platelet and neutrophil activation were analyzed by repeated-measures ANOVA followed by the Bonferroni correction. Bubble scores were analyzed with the Wilcoxon signed-rank test. Comparisons between dive samples were made with the Student's *t*-test, and correlations were assessed with the Spearman rank order test, with the Bonferroni correction to account for multiple comparisons. Statistics were calculated using the Statistica 7.0 software (StatSoft, Inc., Tulsa, OK).

RESULTS

Diving and intravascular bubbles. There were no adverse effects reported from any of the subjects after exercise and scuba diving activities. Data for the 14 males and five females are grouped together. The median bubble score, taken at rest, was unchanged between the EX and the CON dives. The median score for both dives was 3 at the 15-, 40-, and 80-min measurements and 2 at the 120-min measurement (Table 1). However, overall, VGE grades were significantly higher in the EX group at the 40- and 80-min measurements at rest and at 80- and 120-min measurements during the voluntary leg contractions ($P = 0.047$, 0.004, 0.003, and 0.043, respectively).

Platelets, leukocytes, and hematocrit. Platelet counts (Table 2) were significantly reduced after the EX dive compared with those after the CON dive at all measured time points after surfacing (15 min, $P = 0.013$; 2 h,

TABLE 1. Descriptive statistics of VGE analysis after CON and EX dives.

	15 min Postsurface		40 min Postsurface		80 min Postsurface		120 min Postsurface	
	CON	EX	CON	EX	CON	EX	CON	EX
Maximal	4C (5)	4C (5)	4B (4C)	4C (5)	4B (4C)	4B (4C)	3 (3)	3 (4B)
75th	4B (4C)	4B (4C)	3 (4B)	4C (4C)	3 (4A)	3 (4B)	2 (3)	3 (3)
Median	3 (4B)	3 (4C)	3 (4B)	3* (4C)	3 (3)	3* (4B)*	2 (2)	2 (3)*
25th	3 (3)	3 (3)	3 (4A)	3 (3)	2 (3)	3 (3)	1 (2)	1 (2)
Minimal	0 (0)	1 (2)	0 (2)	1 (3)	0 (1)	0 (1)	0 (1)	0 (0)

Median, maximal, minimal, and quartile data for bubble grades at rest and during voluntary leg contractions (in parentheses). Nonparametric values are presented as modified Brubakk scale for bubble grading.

* $P \leq 0.05$ of median value of EX compared with that in CON at the same time point.

$P = 0.037$; 4 h, $P = 0.002$; and 24 h, $P = 0.003$). Leukocytes were significantly increased by exercise when measured before diving ($P = 0.0002$) and were also significantly increased by diving during both the EX and CON dives ($P = 0.000$ and 0.002) (Table 2). Hematocrit (Hct) was significantly increased compared with pre-dive values after surfacing after the CON and EX dives at 15-min, 2-h, and 4-h time points and returned to baseline after 24 h in the EX dive but not in the CON dive (Table 2). Both the CON and EX dives follow the same pattern; there was no significant difference in the mean values of Hct other than that before diving, where it was significantly elevated after exercise ($P = 0.013$) (Table 2).

Platelet activation. Platelet activation was assessed as surface expression of CD63 and CD62P, as described in Methods. The percent of all platelets expressing these activation-associated markers is shown in Figure 1A and B, and geometric mean fluorescence is shown in Figure 1C and D. Exercise increased platelet activation; however, activation was significantly lower postdiving when compared with that after the CON dive.

Neutrophil activation. Neutrophil activation was assessed as surface expression of CD18 and MPO on CD66b-positive cells (Fig. 2A and B). Activation occurred after the CON and EX dives, with a significant difference at all postdiving measurements of CD18 and at 15 min, 2 h, and 24 h for MPO. Platelet–neutrophil interactions were evaluated as the presence of CD41 on CD66b-positive cells (Fig. 2C). Notably, there was an increase in CD41 mean fluorescence after pre-dive exercise and it remained elevated after the dive. After the CON dive, fluorescence was increased compared with both pre-dive values and compared with values at all time points of the EX dive.

MP response. Circulating MP and enlarged MP counts related to the EX and CON dives are displayed in Figure 3A and B, respectively. There was no significant difference in

annexin V-positive MP (0.3–1 μm) before exercise and before diving on the day of the CON dive, indicating no difference in baseline among divers before the two different dive conditions. MP increased significantly at all time points up to 4 h in both dives. There was a significant difference in MP number between EX and CON dives at all four post-dive measurements, with lower response in the EX group. Elevated MP values persisted for 24 h after both dive conditions but were only significant after the CON dive. Elevations of large MP occurred after the CON dive in a pattern similar to the 0.3- to 1- μm MP but not after the postexercise dive.

MP expressing the platelet-specific CD41a surface protein are displayed in Figure 4A, and those expressing the neutrophil-specific CD66b are displayed in Figure 4B. These subtypes of MP increased after both CON and postexercise diving and peaked by the 2-h sample. Significantly, fewer MP expressing CD41 and CD66b were present at all sampling time points after surfacing (15 min and 2, 4, and 24 h) in the EX dive compared with those after the CON dive. MP expressing CD41 and CD66b remained elevated 24 h post-dive in both groups.

Correlations between variables. Correlations between variables were tested on the basis of previous research and hypotheses. After the CON dive, a positive correlation was found between enlarged MP and BG (at rest and during leg compressions) 15 min after surfacing ($r = 0.636$ and 0.561 , $P = 0.003$ and 0.013 , respectively). After pre-dive exercise, a positive correlation was found between platelet count at 120 min after surfacing and large MP ($r = 0.526$, $P = 0.012$).

DISCUSSION

We set out to further investigate the interactions between MP and VGE and explore the effect of pre-dive exercise because of recent animal and human data pointing to decompression stress as an acute vascular injury with an

TABLE 2. Time course of Hct, platelets, and leukocytes in CON and EX groups.

		BX	BD	15 min	2 h	4 h	24 h
Platelets ($\times 10^5$)	EX	2.25 \pm 0.30	2.55 \pm 0.46***	2.74 \pm 0.35***	2.91 \pm 0.29***	2.89 \pm 0.35***	2.35 \pm 0.37*
	CON		2.74 \pm 0.54	3.10 \pm 0.57**	3.17 \pm 0.55**	3.25 \pm 0.36**	2.73 \pm 0.42
Leukocytes ($\times 10^9 \text{ L}^{-1}$)	EX	6.03 \pm 1.25	7.55 \pm 1.69***	9.16 \pm 1.86***			
	CON		6.03 \pm 1.42	6.69 \pm 1.38**			
HCT (%)	EX	47.32 \pm 1.73	48.16 \pm 1.54*	48.74 \pm 1.33**	49.89 \pm 1.15**	49.26 \pm 1.45**	47.47 \pm 1.43*
	CON		47.16 \pm 1.26	48.84 \pm 1.17**	49.21 \pm 2.55**	49.53 \pm 1.35**	48.16 \pm 1.50**

Values are presented as mean \pm SD.

* $P \leq 0.05$ at same time point between EX and CON.

** $P \leq 0.05$ between selected time point and before dive measurement.

BD, measurement taken before diving; BX, measurement taken before exercise.

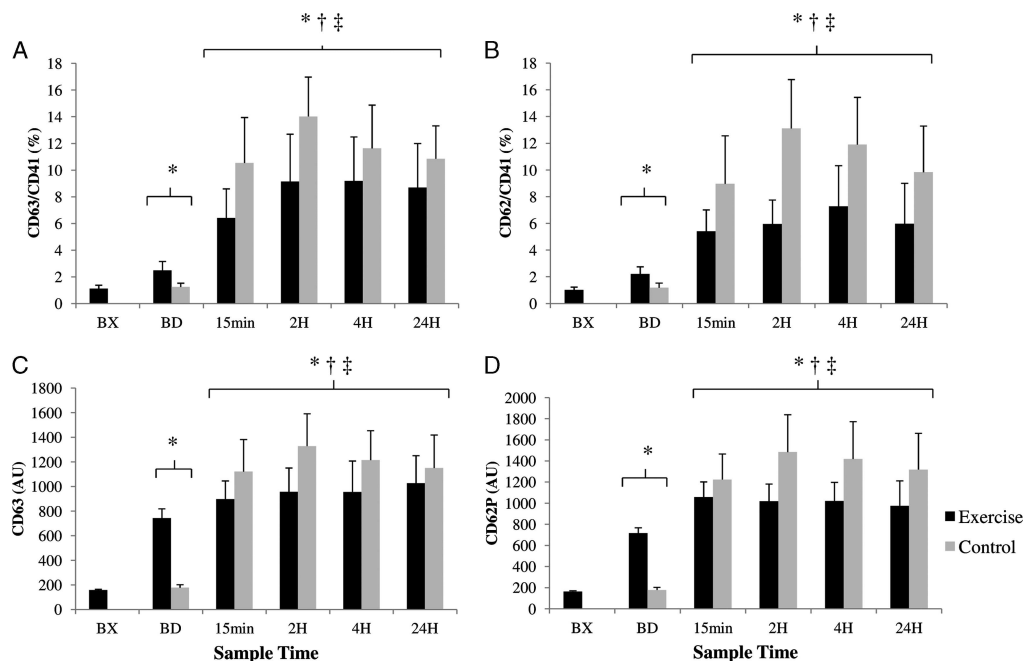

FIGURE 1—Platelet activation as percent and mean fluorescence. Platelet activation shown as percent CD41-positive MP coexpressing the CD63 (A) and CD62 activation associated surface proteins (B). CD41/CD63 (C) and CD41/CD63 mean fluorescence (D). AU, arbitrary units; BD, sample taken before diving (both dives); BX, sample taken before exercise (EX dive only). * Value is significantly different in MP count at the same time point between EX and CON dives. † Value is significantly different from BD values in EX dive. ‡ Value is significantly different from BD values in CON dive.

inflammatory response. Results from the study provide the following observations with exercise 2 h before diving compared with a nonexercising CON group: 1) no change in median VGE but increased 75th percentiles and maximal bubble scores at 40 and 80 min after surfacing after the EX dive compared with those after the CON dive, 2) smaller increases in platelet counts at all time measurements, 3) increased leukocyte counts prediving, 4) fewer circulating MP, 5) a smaller increase in CD41- and CD66b-positive MP, 6) evidence of platelet activation prediving but less activation postdiving, and 7) less evidence of platelet–neutrophil interactions. These observations provide additional information in the relation between exercise, MP, and VGE.

Whereas previous studies have demonstrated a beneficial effect of exercise on the basis of a reduction of VGE (3,9,13), we did not observe similar outcomes. These data are contrary to previous studies where exercise before diving was found to result in a clear reduction in postdive bubbles (3,4,8,9,13). There are many factors that influence VGE production outside exercise, including fatigue, environmental conditions, and, more recently, acclimatization to repeated bouts of scuba diving (1). It is possible that any one of these could have contributed to differences between studies and overshadowed any potential changes in VGE activity resulting from the exercise intervention. Moreover, the effect of using alternate bubble grading techniques, scales, and equipment on the magnitude of these differences cannot be ruled out as well.

It has also been proposed that alterations in hemodynamics are related to dehydration as a potential mechanism of changes in VGE after exercise (2). In the present study, subjects were allowed water *ad libitum* at all times, including the exercise sessions. Although Hct was progressively higher at each time point after surfacing after both dives, the elevations were not significantly different between the groups (Table 2). Significant only within each group, these changes appear within normal values, and there are other aspects of exercise that can lead to increased hemo concentration. This maintenance of hydration status could partially explain the lack of significant changes in VGE grades between the two trials.

Platelet counts were significantly reduced after the EX dive compared with those after the CON dive at all measurements and are displayed in Table 2. It is important to note that the prediving values (baseline) are significantly higher in the CON dive than the preexercise values in the EX dive (Table 2). That is, the subjects began the day of experiments (before any intervention including diving and exercise) with a higher platelet count on the control day compared with that in the exercise day and the difference seems to be related to the different baseline values. It is not clear what is responsible for these different baseline values. Markers of platelet activation including surface coexpression of CD62P/CD41 and CD63/CD41 glycoproteins show significant reductions in postdiving increase after EX compared with those after the CON dive (Fig. 1). Increased platelet

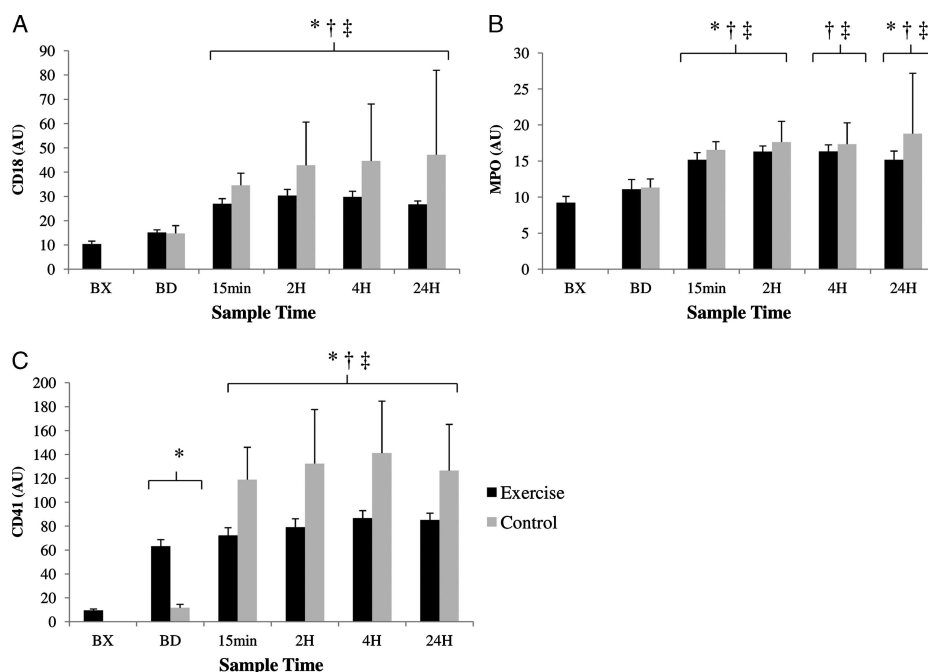

FIGURE 2—Geometric mean fluorescence representing neutrophil activation. Neutrophil activation identified by CD66b staining and coexpression of CD18 (A), MPO (B), and CD41 (C) shown as geometric mean fluorescence AU (arbitrary units) for each marker. BD, sample taken before diving (both dives); BX, sample taken before exercise (EX dive only). *Value is significantly different in MP count at the same time point between EX and CON dives. †Value is significantly different from BD values in EX dive. ‡Value is significantly different from BD values in CON dive.

activation is associated with DCS in the rat model (26), and platelet activation in humans is associated with damaging thrombotic events.

It is clear that exercise before diving has an effect on annexin V-positive MP count and subtype expression after diving. First, this experiment provides new data on MP, platelet, and leukocyte responses up to 24 h after surfacing. Whereas exercise caused an increase in MP, consistent with reports by others, paradoxically, elevations in the absolute number of circulating MP are significantly less when diving is preceded by exercise (Fig. 3A), warranting further studies on the protective effect of exercise. Total MP counts remained elevated 24 h after diving, with larger increases above baseline seen in the CON dive. Enlarged MP (1–3 μm) (Fig. 3B) were evaluated as well. Although absolute numbers were different between the two dives, the proportion of enlarged to regular MP was similar. We found a relation between enlarged MP and ultrasonic scannable VGE under some diving conditions in a previous study (29), although the correlation was weak and not always in the same direction. Although results from a murine study suggest that MP containing an intranitrogen dioxide phase serve as nucleation points for inert gas released from the tissues during decompression, we have not made similar observations in humans under these conditions. It was hypothesized that uptake of inert gas facilitates expansion of MP to enlarged MP (1–3 μm in diameter) that may be visualized ultrasonically. In the present study, a significant positive correlation

was seen between large MP and BG 15 min after surfacing ($r = 0.636$, $P = 0.003$) only in the CON dive. Regardless of the relation between MP and VGE, there remains strong evidence that these large MP are related to vascular damage. Naive mice injected with these particles exhibit signs and symptoms of DCS, and recompression, resulting in a reduction in size of these particles, ameliorates these symptoms (30).

Platelet and neutrophil activation and interactions are associated with DCS in mice. Platelet-derived MP (Fig. 4A) play a key role in neutrophil activation (30), and the reduction after the EX dive could be related to a reduction in neutrophil activation observable as decreased CD66b (Fig. 4B) and MPO expression (Fig. 2B). A decrease in CD66b expressing MP was also associated with a decrease in vascular injuries in mice (30), although further investigation is needed to determine whether these risks are present and subsequently ameliorated by exercise before open-water diving in humans.

It is unclear whether reductions in MP counts after dives preceded by exercise compared with those after CON dives are related to an increased rate of uptake or a decrease in production. Currently, little is known about MP clearance and elimination. Phagocytosis is believed to be the primary means of MP clearance, as has been demonstrated by Distler et al. *in vitro* (7). It is believed that this is a result of the interaction between MP surface expression of phosphatidylserine and splenic macrophages. An alternative clearance pathway consisting of MP binding via surface expression of Del-1 was

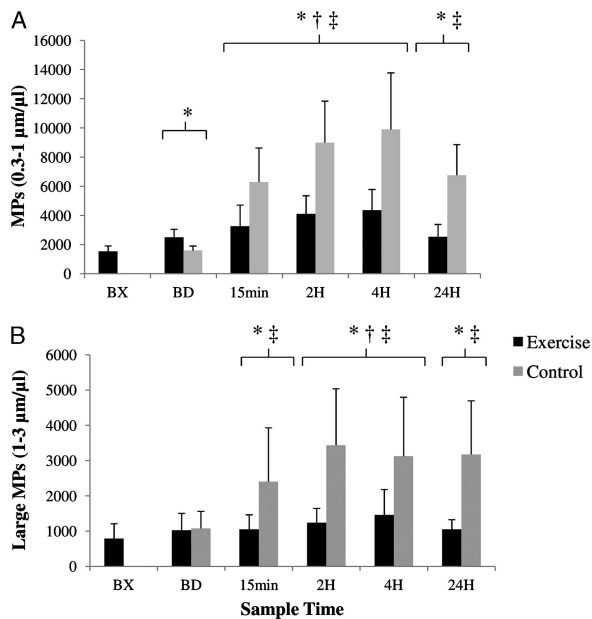

FIGURE 3—Total circulating MP and enlarged MP. Data show mean of circulating MP (0.3–1.0 $\mu\text{m}\cdot\mu\text{L}^{-1}$) (A) and enlarged MP (1.0–3.0 $\mu\text{m}\cdot\mu\text{L}^{-1}$) (B). BD, sample taken before diving (both dives); BX, sample taken before exercise (EX dive only). *Value is significantly different in MP count at the same time point between EX and CON dives. †Value is significantly different from BD values in EX dive. ‡Value is significantly different from BD values in CON dive.

associated with the ability of endothelial cells to internalize MP, describing a potentially more widespread clearance from vascular beds (6). This implies a complex relation between exercise, diving, and endothelial function, which is worth further investigation. Intense exercise can stimulate an acute increase of circulating leukocytes followed by a decrease as they move from the blood to the periphery in preparation to support a “fight or flight” response (34). It is possible that sympathetic activation associated with this immune response could be responsible for increased uptake and destruction of MP; our data show a significantly increased leukocyte count before and 15 min after diving in the EX group compared with that in the CON group. Regardless of the mechanism, more research is needed to determine whether the reduction in MP and concomitant diminution in neutrophil activation associated with exercise are related to the protective effect of exercise, which has been shown to reduce the incidence of DCS in mice.

In conclusion, our results provide additional insight into the interaction of exercise and scuba diving as well as the relation between VGE and MP. This study shows a clear reduction in MP counts and platelet and neutrophil activation with exercise before diving relative to diving alone, although these changes are not associated with VGE in a statistically significant manner. In the present study, these changes in MP have been clinically asymptomatic. Surprisingly, even a dive that would be considered mild by even recreational standards (18-m seawater depth, 41-min bottom time)

produced approximately twice as many MP as what many people would consider a challenging exercise session (60 min total, 8 × 3 min intervals of high-intensity running). Additional work on the dose–response relations between exercise variables such as mode, intensity, and timing relative to diving is also needed.

Although exercise is not considered dangerous, some manageable level of damage is necessary to disrupt homeostasis enough to drive supercompensation. MP seem to be an additional part of this disruption for both exercise and diving. There may be a certain threshold that, once exceeded, would lead to negative effects in humans, as it has been demonstrated in mice. Additional studies should include MP analysis of divers that report to hyperbaric centers for treatment of DCS to determine when these levels become clinically significant. As with changes in cardiovascular parameters, endothelial function, and VGE after diving, MP represent an additional physiological consequence that remains mostly asymptomatic. However, these alterations can also contribute to DCS and diving injuries, and observing thresholds at which this may occur and how this relates to a diver’s current health status, as well as the long-term effects, are still to be determined.

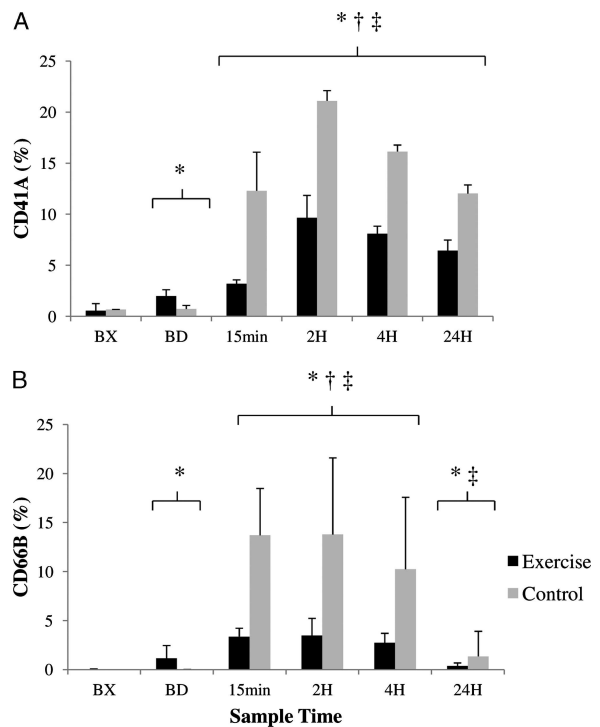

FIGURE 4—Percentage of MP expressing CD41a and CD66b. Data show MP expressing the platelet-associated CD41a surface marker as a percentage of total circulating MP (A) and neutrophil MP as a percentage of total circulating MP identified by the CD66b surface protein (B). BD, sample taken before diving (both dives); BX, sample taken before exercise (EX dive only). *Value is significantly different in MP count at same time point between EX and CON dives. †Value is significantly different from BD values in EX dive. ‡Value is significantly different from BD values in CON dive.

We would like to thank Mislav Lozo, Ivana Banic, and Ivana Dragicevic for their hard work, professionalism, and technical expertise.

The funding for this work was provided by a grant from the Office of Naval Research. This work was supported by the FP7-PEOPLE-

2010-ITN (264816 PHYPODE) and the Croatian Ministry of Science, Education, and Sports (grant no. 216-2160133-0130 to Z. D.).

The authors declare no conflict of interest.

The results of the present study do not constitute endorsement by the American College of Sports Medicine.

REFERENCES

1. Bilopavlovic N, Marinovic J, Ljubkovic M, et al. Effect of repetitive SCUBA diving on humoral markers of endothelial and central nervous system integrity. *Eur J Appl Physiol*. 2013;113(7):1737–43.
2. Blatteau JE, Boussuges A, Gempp E, et al. Haemodynamic changes induced by submaximal exercise before a dive and its consequences on bubble formation. *Br J Sports Med*. 2007;41(6):375–9.
3. Blatteau JE, Gempp E, Galland FM, Pontier JM, Sainty JM, Robinet C. Aerobic exercise 2 hours before a dive to 30 msw decreases bubble formation after decompression. *Aviat Space Environ Med*. 2005;76(7):666–9.
4. Castagna O, Brisswalter J, Vallee N, Blatteau JE. Endurance exercise immediately before sea diving reduces bubble formation in scuba divers. *Eur J Appl Physiol*. 2011;111(6):1047–54.
5. Chaar V, Romana M, Tripette J, et al. Effect of strenuous physical exercise on circulating cell-derived microparticles. *Clin Hemorheol Microcirc*. 2011;47(1):15–25.
6. Dasgupta SK, Le A, Chavakis T, Rumbaut RE, Thiagarajan P. Developmental endothelial locus-1 (DeL-1) mediates clearance of platelet microparticles by the endothelium. *Circulation*. 2012;125(13):1664–72.
7. Distler JH, Akhmetshina A, Dees C, et al. Induction of apoptosis in circulating angiogenic cells by microparticles. *Arthritis Rheum*. 2011;63(7):2067–77.
8. Dujic Z, Duplancic D, Marinovic-Terzic I, et al. Aerobic exercise before diving reduces venous gas bubble formation in humans. *J Physiol*. 2004;555(Pt 3):637–42.
9. Dujic Z, Valic Z, Brubakk AO. Beneficial role of exercise on scuba diving. *Exerc Sport Sci Rev*. 2008;36(1):38–42.
10. Eftedal O, Brubakk AO. Agreement between trained and untrained observers in grading intravascular bubble signals in ultrasonic images. *Undersea Hyperb Med*. 1997;24(4):293–9.
11. Enjeti AK, Lincz LF, Seldon M. Detection and measurement of microparticles: an evolving research tool for vascular biology. *Semin Thromb Hemost*. 2007;33(8):771–9.
12. Enjeti AK, Lincz LF, Seldon M. Microparticles in health and disease. *Semin Thromb Hemost*. 2008;34(7):683–91.
13. Gempp E, Blatteau JE. Preconditioning methods and mechanisms for preventing the risk of decompression sickness in scuba divers: a review. *Res Sports Med*. 2010;18(3):205–18.
14. Gennser M, Jurd KM, Blogg SL. Pre-dive exercise and post-dive evolution of venous gas emboli. *Aviat Space Environ Med*. 2012;83(1):30–4.
15. Hugel B, Martinez MC, Kunzelmann C, Freyssinet JM. Membrane microparticles: two sides of the coin. *Physiology (Bethesda)*. 2005;20:22–7.
16. Klingmann C, Rathmann N, Hausmann D, Bruckner T, Kern R. Lower risk of decompression sickness after recommendation of conservative decompression practices in divers with and without vascular right-to-left shunt. *Diving Hyperb Med*. 2012;42(3):146–50.
17. Ljubkovic M, Dujic Z, Mollerlokken A, et al. Venous and arterial bubbles at rest after no-decompression air dives. *Med Sci Sports Exerc*. 2011;43(6):990–5.
18. Maruyama K, Kadono T, Morishita E. Plasma levels of platelet-derived microparticles are increased after anaerobic exercise in healthy subjects. *J Atheroscler Thromb*. 2012;19(6):585–7.
19. Mause SF, Weber C. Microparticles: protagonists of a novel communication network for intercellular information exchange. *Circ Res*. 2010;107(9):1047–57.
20. Mobius-Winkler S, Hilberg T, Menzel K, et al. Time-dependent mobilization of circulating progenitor cells during strenuous exercise in healthy individuals. *J Appl Physiol (1985)*. 2009;107(6):1943–50.
21. Mollerlokken A, Breskovic T, Palada I, Valic Z, Dujic Z, Brubakk AO. Observation of increased venous gas emboli after wet dives compared to dry dives. *Diving Hyperb Med*. 2011;41(3):124–8.
22. Olszanski R, Radziwon P, Piszcz J, et al. Activation of platelets and fibrinolysis induced by saturated air dives. *Aviat Space Environ Med*. 2010;81(81):585–8.
23. Papadopoulou V, Eckersley RJ, Balestra C, Karapantsios TD, Tang MX. A critical review of physiological bubble formation in hyperbaric decompression. *Adv Colloid Interface Sci*. 2013;191–192:22–30.
24. Pontier JM, Gempp E, Ignatescu M. Blood platelet-derived microparticles release and bubble formation after an open-sea air dive. *Appl Physiol Nutr Metab*. 2012;37(5):888–92.
25. Pontier JM, Jimenez C, Blatteau JE. Blood platelet count and bubble formation after a dive to 30 msw for 30 min. *Aviat Space Environ Med*. 2008;79(12):1096–9.
26. Pontier JM, Vallee N, Bourdon L. Bubble-induced platelet aggregation in a rat model of decompression sickness. *J Appl Physiol (1985)*. 2009;107(6):1825–9.
27. Sossdorf M, Otto GP, Claus RA, Gabriel HH, Losche W. Cell-derived microparticles promote coagulation after moderate exercise. *Med Sci Sports Exerc*. 2011;43(7):1169–76.
28. Thom SR, Milovanova TN, Bogush M, et al. Microparticle production, neutrophil activation, and intravascular bubbles following open-water SCUBA diving. *J Appl Physiol (1985)*. 2012;112(8):1268–78.
29. Thom SR, Milovanova TN, Bogush M, et al. Bubbles, microparticles and neutrophil activation: changes with exercise level and breathing gas during open-water SCUBA diving. *J Appl Physiol (1985)*. 2013;114(10):1396–1405.
30. Thom SR, Yang M, Bhopale VM, Huang S, Milovanova TN. Microparticles initiate decompression-induced neutrophil activation and subsequent vascular injuries. *J Appl Physiol (1985)*. 2011;110(2):340–51.
31. Thom SR, Yang M, Bhopale VM, Milovanova TN, Bogush M, Buerk DG. Intramicroparticle nitrogen dioxide is a bubble nucleation site leading to decompression-induced neutrophil activation and vascular injury. *J Appl Physiol (1985)*. 2013;114(5):550–8.
32. van Velzen JF, Laros-van Gorkom BA, Pop GA, van Heerde WL. Multicolor flow cytometry for evaluation of platelet surface antigens and activation markers. *Thromb Res*. 2012;130(1):92–8.
33. Vince RV, McNaughton LR, Taylor L, Midgley AW, Laden G, Madden LA. Release of VCAM-1 associated endothelial microparticles following simulated SCUBA dives. *Eur J Appl Physiol*. 2009;105(4):507–13.
34. Walsh NP, Gleeson M, Pyne DB, et al. Position statement. Part two: maintaining immune health. *Exerc Immunol Rev*. 2011;17:64–103.
35. Wisloff U, Brubakk AO. Aerobic endurance training reduces bubble formation and increases survival in rats exposed to hyperbaric pressure. *J Physiol*. 2001;537:607–11.
36. Yang M, Milovanova TN, Bogush M, Uzun G, Bhopale VM, Thom SR. Microparticle enlargement and altered surface proteins after air decompression are associated with inflammatory vascular injuries. *J Appl Physiol (1985)*. 2012;112(1):204–11.

High intensity cycling before SCUBA diving reduces post-decompression microparticle production and neutrophil activation

Dennis Madden · Stephen R. Thom · Ming Yang ·
Veena M. Bhopale · Marko Ljubkovic · Zeljko Dujic

Received: 3 March 2014 / Accepted: 24 May 2014 / Published online: 11 June 2014
© Springer-Verlag Berlin Heidelberg 2014

Abstract

Background Venous gas emboli (VGE) have traditionally served as a marker for decompression stress after SCUBA diving and a reduction in bubble loads is a target for pre-condition procedures. However, VGE can be observed in large quantities with no negative clinical consequences. The effect of exercise before diving on VGE has been evaluated with mixed results. Microparticle (MP) counts and sub-type expression serve as indicators of vascular inflammation and DCS in mice. The goal of the present study is to evaluate the effect of anaerobic cycling (AC) on VGE and MP following SCUBA diving.

Methods Ten male divers performed two dives to 18 m for 41 min, one dive (AC) was preceded by a repeated-Wingate cycling protocol; a control dive (CON) was completed without exercise. VGE were analyzed at 15, 40, 80, and 120 min post-diving. Blood for MP analysis was collected before exercise (AC only), before diving, 15 and 120 min after surfacing.

Results VGE were significantly lower 15 min post-diving in the AC group, with no difference in the remaining measurements. MPs were elevated by exercise and diving, however, post-diving elevations were attenuated in the AC dive. Some markers of neutrophil elevation (CD18, CD41) were increased in the CON compared to the AC dive.

Conclusions The repeated-Wingate protocol resulted in an attenuation of MP counts and sub-types that have been related to vascular injury and DCS-like symptoms in mice. Further studies are needed to determine if MPs represent a risk factor or marker for DCS in humans.

Keywords SCUBA diving · Exercise · Microparticles · Neutrophil activation · High intensity

Abbreviations

AC	Anaerobic cycling
ANOVA	Analysis of variance
BMI	Body mass index
BS	Bubble score
C	Centigrade
CON	Control
DCS	Decompression sickness
HIT	High intensity training
HR	Heart rate
MP	Microparticles
MPO	Myeloperoxidase
NO	Nitric oxide
SCUBA	Self-contained underwater breathing apparatus
SD	Standard deviation
VGE	Venous gas emboli
VO _{2max}	Maximal volume of oxygen uptake

Communicated by Guido Ferretti.

D. Madden · M. Ljubkovic · Z. Dujic (✉)
Department of Physiology, University of Split School
of Medicine, Soltanska 2, 21000 Split, Croatia
e-mail: zeljko.dujic@mefst.hr

S. R. Thom · M. Yang · V. M. Bhopale
Department of Emergency Medicine, University of Maryland,
Baltimore, MD 21201, USA

Introduction

SCUBA diving remains a popular recreational activity as well as a primary working environment for commercial and military divers. Although diving procedures have become safer over time, decompression sickness (DCS) still remains a risk, even for recreational divers. Additionally,

commercial and military divers continuously push the limits of decompression tables and can be higher risk than recreational diving. Therefore, the investigation of procedures to ameliorate these risks remains relevant to these populations.

The use of exercise before diving as a protective measure against stress and DCS has been investigated with mixed results. Positive outcomes, based on decreased observations of venous gas emboli (VGE) post-diving, have been observed in a variety of studies utilizing almost exclusively aerobic running for 45–90 min, completed 2–24 h prior to diving (Castagna et al. 2011; Dujic et al. 2004; Blatteau et al. 2005). However, VGE observations alone are not strong enough to predict DCS due to the common observation of clinically “silent” bubble loads (Eckenhoff et al. 1990). Additional proposed benefits of exercise include activation of heat shock proteins (Medby et al. 2008) and increased NO production resulting in the protection of endothelial function (Dujic et al. 2008). How these directly relate to VGE production and loads is not fully understood.

In addition to VGE, it has been proposed that cellular MPs follow specific stressful events such as myocardial infarction (Zielinska et al. 2005) and exercise (Chaar et al. 2011) act as quantifiable biomarkers (Burger et al. 2013). Annexin V-positive microparticles (MPs) have been correlated to the development of vascular injuries and DCS symptoms after diving in mice (Thom et al. 2011; Yang et al. 2012a). More specifically, neutrophil activation and interactions, measured in part by identifying surface markers on MPs, appear to play a key role in this process (Thom et al. 2011, 2012) in mice. MP levels and sub-types associated with platelet and neutrophil interactions and activation have been elevated following SCUBA diving as well as exercise in humans, however, there is limited data on the combination of the two activities (Thom et al. 2013). Finally, the relationship between MPs, neutrophil activation, vascular injury and DCS has yet to be demonstrated in humans, although the role of MPs in pathogenesis of certain diseases is now recognized (Burger et al. 2013; Anderson et al. 2010; Trappenburg et al. 2012).

Over the past decade, the study of high intensity training (HIT) has become more popular as research continues to compare the benefits of short duration HIT compared to longer aerobic sessions for health benefits (Kessler et al. 2012) and athletic performance (Enoksen et al. 2011). There is little information on how this type of intense training effects subsequent diving. The proposed benefit that aerobic exercise has on SCUBA diving has been attributed to alterations in cardiac parameters secondary to dehydration (Blatteau et al. 2007) and increased NO production (Dujic et al. 2008). It is possible that exercises

shorter in duration than those used in aerobic studies (45–90 min) may not be long enough for the subject to adequately dehydrate through sweat loss. Previously, we have conducted pilot studies on various exercise protocols to determine their impact on MP counts and sub-types and have found that HIT cycling compares relatively well to aerobic running intervals related to MP production (Madden et al. 2014). Additionally, this protocol is short, easy to regulate and standardize, and could easily be implemented with minimal training and equipment in a variety of facilities. We have selected this protocol for these reasons and hypothesized that this protocol would impact MPs similarly to longer duration aerobic exercise with minimal impact on VGE production. Furthermore, to our knowledge, only one diving and exercise study has used cycling as the mode of exercise (Gennser et al. 2012) and this study was conducted in simulated diving conditions, rather than open water. The goal of this study is to compare VGE as well as MP counts and sub-types in a dive preceded by anaerobic cycling (AC) compared to a control dive (CON) of equal depth and duration without the exercise intervention.

Methods

Ethics statement

After receiving a written explanation and an oral briefing of the methods and potential risks, all subjects gave their written informed consent. This study was approved by the University of Split School of Medicine Ethics Committee and all procedures were conducted in accordance with the Declaration of Helsinki.

Participants

Ten male experienced divers [ages (mean \pm SD) 38 ± 6 years] with 14.1 ± 9 years of diving were recruited from local military and professional organizations and participated in this study. Maximal oxygen consumption (VO_{2max}) was 36.5 ± 3.4 ml/kg/min, while mean body mass index was 27.4 ± 2.5 kg/m². Divers were apparently healthy at the beginning of the study and recently given clearance to dive by a physician. No subjects reported previous cases of DCS. Prior to participating in the study all subjects completed a VO_{2max} treadmill test, pulmonary function testing (forced vital capacity and maximal voluntary ventilation) and anthropometrical measurements were recorded. Body density was estimated by measurement of subcutaneous skin fold thickness with a caliper (Harpender skinfold caliper, Baly International, West Sussex, England) for the calculation of body composition.

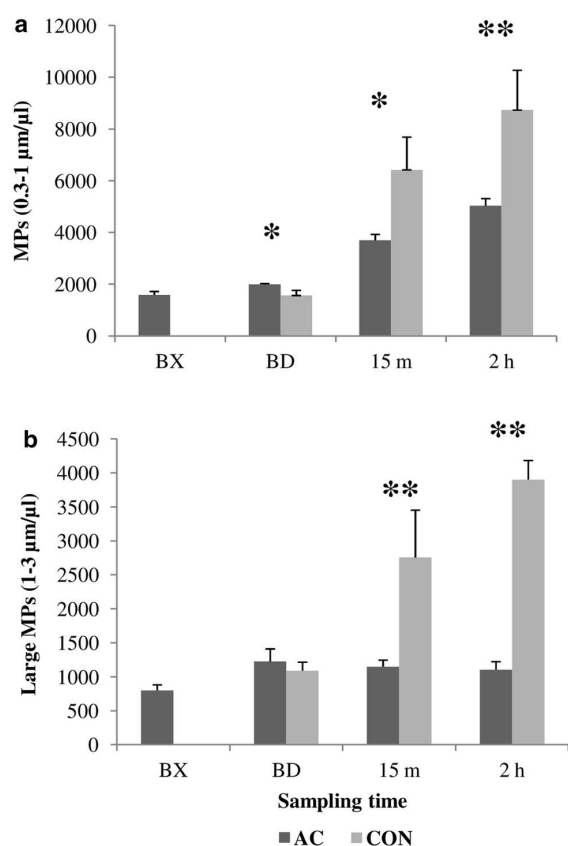

Fig. 1 Total circulating MPs and enlarged MPs. Data show mean of circulating **a** MPs (0.3–1.0 µm)/µl and **b** enlarged MPs (1.0–3.0 µm)/µl. *BX* sample taken before exercise (AC dive only). *BD* sample taken before diving, both dives. * $p < 0.025$, ** $p < 0.01$, significance between MP count at same time point between AC and CON dives

Study protocol

Following recruitment, subjects reported to the University of Split School of Medicine for anthropometrical assessment, pulmonary function testing, and a treadmill $\text{VO}_{2\text{max}}$ test. All subjects were assigned to complete a control dive followed, 3 days later, by the exercise intervention and dive. All measurements following both dives were completed within 2 h after surfacing. The study was concluded immediately upon completion of the data collection after the exercise intervention dive.

Dive protocol and VGE measurement

This study was performed at a military installation of the Croatian Navy. The dive site was located in the vicinity of the base, within a short (approximately 30 m) distance

from the location where the experiments would take place. All divers performed the dive at a depth of 18 m sea water (msw) with a bottom time of 41 min. This dive profile was selected with dive planning software built into Galileo dive computers (Uwatec Galileo Sol, Johnson Outdoors, Racine, WI, USA). Decompression was performed at an ascent rate of 9 msw/min, with a direct ascent to the surface. Sea temperature at the bottom was approximately 11 °C and the outside temperature was approximately 19 °C. Throughout the dive, divers performed swimming of moderate intensity and heart rate (HR) was monitored via dive computers. Within 8–15 min after surfacing, the divers were placed in the supine position where a dual frequency (1.5–3.3 MHz) ultrasonic probe connected to a Vivid q scanner (GE, Milwaukee, WI, USA) was used to obtain a clear apical four chamber view of the heart. VGE were monitored at 15, 40, 80, and 120 min after surfacing and bubble scores were recorded and graded on a scale of 0–5 with four being subdivided into 4A, 4B, and 4C according to the method described by Eftedal and Brubakk and later modified by Ljubkovic et al. (2012).

Exercise protocol

Subjects performed a repeated-Wingate protocol for the AC condition of the study. This consisted of four, 30 s maximal efforts on a weight-braked cycle ergometer (Monark 894E, Monark Exercise AB, Sweden) with 4 min active recovery between efforts, preceded by a 5 min warm up. The resistance was set at 7.5 % bodyweight for the intervals and 2 % for the warm up and active recovery periods.

Blood collection and MP analysis

Venous blood was collected by a trained phlebotomist 30 min prior to and at 15 and 120 min after surfacing. Blood was drawn into Cyto-Chex BCT test tubes that contain a proprietary preservative (Streck, Inc., Medimark Europe, Grenoble, France). The volume drawn per sample was approximately 5 ml for MP counts and sub-type analysis. Blood for MP analysis was stored at 4 °C until it was shipped to the University of Pennsylvania for analysis. Details and standard procedures for MP and neutrophil acquisition and processing can be found in detail in our previous study (Thom et al. 2013). Briefly, flow cytometry was performed with a 10-color FACSCanto (Becton–Dickinson, San Jose, CA) using standard acquisition software. MPs were stained with annexin V antibody and analyzed including micro-beads with diameters of 0.3 µm (Sigma, Inc.), 1.0, 3.0 and 5 µm (Spherotech, Inc., Lake Forest, IL) to assess the size of particles. We define MPs as annexin V-positive particles with diameters up to 1 µm, enlarged MPs as those between 1 and 3 µm. Platelet activation was

Table 1 Descriptive statistics of VGE analysis following control (CON) and anaerobic cycling (AC) dives

	15 m post surface		40 m post surface		80 m post surface		120 m post surface	
	CON	AC	CON	AC	CON	AC	CON	AC
Max	4B	4B	4B	4B	3	4A	2	3
75th	4B	4A	4B	4A	3	3	2	2
Med	4B	3*	3	3	3	3	2	2
25th	3	2	3	2	3	2	1	1
Min	3	0	2	0	2	0	0	0

Median, maximal, minimal, and quartile data for bubble grades at rest

Non-parametric values presented as modified Brubakk scale for bubble grading

* $p < 0.05$ of median value of AC compared to CON at same time point

assessed by staining samples with CD41 and annexin V antibodies in samples that included micro-beads with diameters of 3 and 5 μm . Samples were stained with antibodies to CD66b, CD18, MPO, and CD41 for analysis of neutrophil activation and platelet interaction. An additional sample of whole blood was analyzed for complete blood counts (CBC). Blood was stored in a cooler and transported to the Department of Biochemistry, University Hospital Split, for analysis within 2 h of obtaining the sample. CBC values were measured with the Abbot Cell-Dyne 4000 cell counter (Abbot Park, IL, USA).

Statistical analysis

Following a Shapiro–Wilk test confirming a normal distribution, MP counts and neutrophil activation were analyzed by repeated measures analysis of variance (ANOVA) followed by a Bonferroni correction. Non-parametric bubble scores were compared with the Wilcoxon signed-rank test. Comparisons between dive samples were made with a Student's t test. Statistics were calculated using Statistica 7.0 software (Statsoft Inc, Tulsa OK, USA).

Results

There were no adverse effects reported from any of the subjects after exercise and SCUBA diving activities. Median bubbles scores (BS), displayed in Table 1, were significantly lower in the cycling group (median BS of 3 compared to 4B, $p = 0.028$) at the 15 min measurement. No significant differences between the groups were observed at 40, 80, or 120 min post-diving (data not shown).

There were no significant differences in leukocyte, erythrocyte, hematocrit (Hct), or thrombocyte counts following the Wingate protocol and before diving (data not shown). Leukocytes were significantly higher 15 min after surfacing following both the AC ($p = 0.014$) and CON ($p = 0.002$) protocol compared to pre-dive values.

Circulating MPs and enlarged MPs related to the AC and CON protocols are displayed in Fig. 1. Total MP counts are elevated following both AC and CON protocols. This increase is significantly lower at both time points following the AC protocol ($p = 0.011$ 15 min and $p = 0.008$ 120 min). Enlarged MP (size 1–3 μm) counts were lower at both measurements in the AC protocol as well ($p = 0.002$ and 0.001). Neutrophil activation was assessed as surface expression of CD18, myeloperoxidase (MPO), and CD41 on CD66b-positive cells and is displayed in Fig. 2. All parameters were elevated following SCUBA diving. There was no significant difference at any time point in MPO mean fluorescence between both conditions. Following the AC dive, there was less of an increase in CD41 fluorescence at both time points, and in CD18 at the 15 min time point.

Discussion

When comparing pre-dive Wingate cycling (AC) to a control dive (CON), we observed the following: (1) decrease in median BS 15 min following AC with no further differences at the other time points. (2) Increase in annexin V-positive MPs following Wingate cycling and both dives, with a significantly higher increase in the CON values compared to AC. (3) Increased MPO, CD18, and CD41 geometric mean values following both dives, with a larger CD18 increase in the CON group 15 min after surfacing and at all post-diving CD41 measurements.

Although there was a significant difference in BS at 15 min, past that time point, the AC protocol did not appear to alter ultrasound detectable bubble loads. A previous study has found no difference in VGE following diving when aerobic cycling protocols were used (Gennser et al. 2012). Suggested mechanisms of studies that describe more significant changes include the effect of dehydration (Castagna et al. 2011) and alterations in cardiovascular parameters following aerobic exercise (Blatteau et al. 2007).

Fig. 2 Geometric mean fluorescence representing neutrophil activation. Neutrophil activation identified by CD66b staining and co-expression of **a** CD41, **b** CD18, and **c** MPO shown as geometric mean fluorescence AU (arbitrary units) for each marker. *BX* sample taken before exercise (AC dive only). *BD* sample taken before diving, both dives. * $p < 0.025$, ** $p < 0.01$, significance between expression at same time point between AC and CON dives

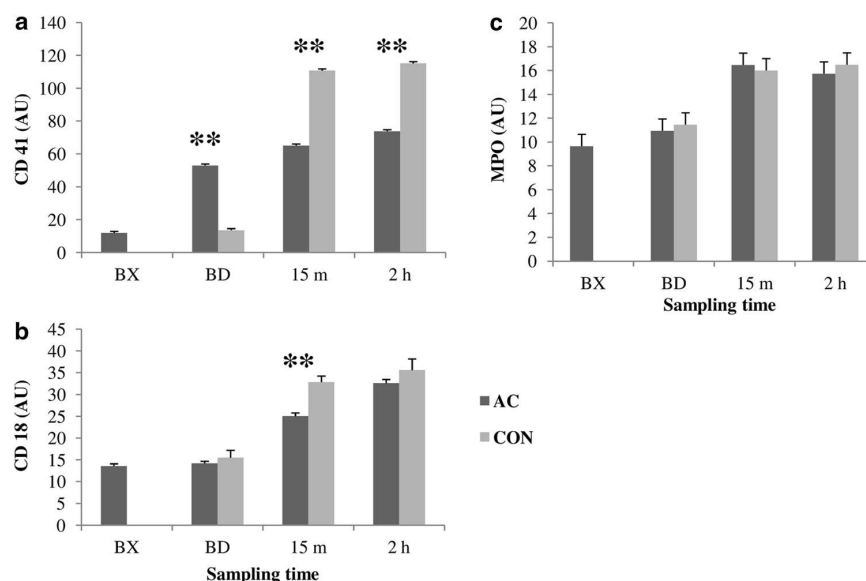

It is possible that the shorter overall exercise duration (23 min) did not allow for enough dehydration to impact bubble loads since water was allowed ad libitum throughout the AC and CON protocols. Furthermore, Hct remained unchanged at all measured time points in both conditions that rules out alterations in cardiovascular performance related to blood volume. Alterations in NO production have also been associated with endothelial function after diving (Marinovic et al. 2012). This is also one of the proposed mechanisms for the decrease in VGE production in dives preceded by aerobic exercise (Dujic et al. 2008). Cocks et al. (2013) has demonstrated that sprint interval training, in this case 4–6 Wingate intervals, can have effects on endothelial nitric oxide synthase production superior to endurance training. Although the interval exercise protocol was similar, values were recorded after 18 sessions, rather than a single bout.

It is important to note that many of these studies showing favorable outcomes based on VGE reduction have been performed in a hyperbaric chamber rather than in open water (Blatteau et al. 2005, 2007; Dujic et al. 2004; Gennser et al. 2012; Jurd et al. 2011; Wisloff and Brubakk 2001) and it has been demonstrated that equal dive profiles in both environments produce different quantifiable VGE loads (Mollerlokken et al. 2011). It is challenging to compare VGE results between multiple studies that utilize a variety of diving and analysis methods. While it may be difficult at best to compare absolute VGE quantities, statistically significant changes between interventions remain a relative indicator of the efficacy of the intervention.

SCUBA diving resulted in an increase in leukocytes following both protocols. The magnitude of the

increase was significantly greater following the AC dive ($p = 0.002$) compared to the control (Δ of $3.9 \times 10^9/l$ AC vs $0.59 \times 10^9/l$ CON). However, it is important to note that pre-dive values were also increased that day compared to the pre-dive values before the control dive ($6.84 \times 10^9/l$ AC vs $6.09 \times 10^9/l$ CON) indicating a different baseline. At this time, we cannot explain these differences and these should be considered when comparing AC and CON trials.

While the AC protocol resulted in an increase in MPs before diving, after surfacing, there was a smaller increase in MPs compared to the control dive. It is not known if this difference is related to decreased MP production or increased clearance. The mechanisms of MP clearance are not yet completely understood; however, it has been demonstrated in vitro that phagocytosis is a means of clearing MPs (Distler et al. 2011). It is possible that this increase in leukocytes could be part of the mechanism responsible for the reduced numbers of circulating MPs although further research is needed before this conclusion can be made.

MP sub-type expression may provide additional indications of specific processes, such as neutrophil activation, which is associated with vascular damage and adverse events in humans and with DCS in mice (Yang et al. 2012a). Annexin V-positive MP injections in mice resulted in intravascular neutrophil activation and adherence to the vascular wall and increased vascular permeability (Thom et al. 2011). Injecting MPs from decompressed mice, but not control mice, into naïve animals will recapitulate tissue injuries seen with decompression stress. These findings not only support a link between MPs and decompression stress, they show that decompression alters the nature of circulating MPs that are produced (Yang et al. 2012b). Changes

may be related to the MP sub-type distribution including increases in CD18, CD41, and MPO expression. In the present study, there is little difference in the MPO and CD18 markers which could be indicators that this type of exercise does not significantly impact diving responses.

It is possible that exercise itself could have served to decrease the population of pre-existing gas micronuclei before the dive, resulting in decreased VGE after diving and ultimately a decreased MP and neutrophil response. This is the proposed mechanism behind other preconditioning techniques such as pre-dive vibration (Germonpre et al. 2009). This again raises one of the original questions related to VGE and MPs; which comes first? Other pre-conditioning methods, such as sauna treatment before diving, show a decrease in VGE as well (Blatteau et al. 2008). The authors propose mechanisms shared with exercise including dehydration and preserved endothelial function, calling into question whether this reduction is related to exercise per se or changes in physiology secondary to exercise. Future studies on how the above techniques alter MP counts and sub-type expression may help answer these questions.

Conclusions

To our knowledge, this is the first study to demonstrate the effect of high intensity interval cycling on SCUBA diving. Although we have demonstrated a decrease in VGE loads immediately after surfacing and an attenuation of MP counts, more information is needed to determine if either of these observations is related to decrease in DCS risk. While VGE often accompany DCS, there is still not enough data to link a decreased bubble load to safer diving. A decrease in MPs and neutrophil activation is favorable in the murine model, but this has yet to be demonstrated in humans. Further exploration is needed on the relationship of MPs and SCUBA diving in humans, as well as potential side effects of exercise that impacts endothelial function and potentially, VGE.

Acknowledgments The research leading to these results has received funding from the People Program (Marie Curie Actions) of the European Union's Seventh Framework Program FRP/2007-2013/ under REA grant agreement n° 264816, the Croatian Ministry of Science, Education and Sports (Grant No. 216-2160133-0130 to ZD) and the Office of Naval Research: ONR grant (Microparticle production with decompression stress - N00014-13-10614).

Conflict of interest The authors declare no conflict of interest.

References

Anderson HC, Mulhall D, Garimella R (2010) Role of extracellular membrane vesicles in the pathogenesis of various diseases,

including cancer, renal diseases, atherosclerosis, and arthritis. *Lab Invest* 90(11):1549–1557

- Blatteau JE, Gempp E, Galland FM, Pontier JM, Sainy JM, Robinet C (2005) Aerobic exercise 2 hours before a dive to 30 msw decreases bubble formation after decompression. *Aviat Space Environ Med* 76(7):666–669
- Blatteau JE, Boussuges A, Gempp E, Pontier JM, Castagna O, Robinet C, Galland FM, Bourdon L (2007) Haemodynamic changes induced by submaximal exercise before a dive and its consequences on bubble formation. *Br J Sports Med* 41(6):375–379
- Blatteau JE, Gempp E, Balestra C, Mets T, Germonpre P (2008) Pre-dive sauna and venous gas bubbles upon decompression from 400 kPa. *Aviat Space Environ Med* 79(12):1100–1105
- Burger D, Schock S, Thompson CS, Montezano AC, Hakim AM, Touyz RM (2013) Microparticles: biomarkers and beyond. *Clin Sci* 124(7):423–441
- Castagna O, Brisswalter J, Vallee N, Blatteau JE (2011) Endurance exercise immediately before sea diving reduces bubble formation in scuba divers. *Eur J Appl Physiol* 111(6):1047–1054
- Chaar V, Romana M, Tripette J, Broquere C, Huisse MG, Hue O, Hardy-Dessources MD, Connes P (2011) Effect of strenuous physical exercise on circulating cell-derived microparticles. *Clin Hemorheol Microcirc* 47(1):15–25
- Cocks M, Shaw CS, Shepherd SO, Fisher JP, Ranasinghe AM, Barker TA, Tipton KD, Wagenmakers AJ (2013) Sprint interval and endurance training are equally effective in increasing muscle microvascular density and eNOS content in sedentary males. *J Physiol* 591(Pt 3):641–656
- Distler JH, Akhmetshina A, Dees C, Jungel A, Sturzl M, Gay S, Piskunov DS, Schett G, Distler O (2011) Induction of apoptosis in circulating angiogenic cells by microparticles. *Arthritis Rheum* 63(7):2067–2077. doi:10.1002/art.30361
- Dujic Z, Duplancic D, Marinovic-Terzic I, Bakovic D, Ivancev V, Valic Z, Eterovic D, Petri NM, Wisloff U, Brubakk AO (2004) Aerobic exercise before diving reduces venous gas bubble formation in humans. *J Physiol* 555(Pt 3):637–642
- Dujic Z, Valic Z, Brubakk AO (2008) Beneficial role of exercise on scuba diving. *Exerc Sport Sci Rev* 36(1):38–42. doi:10.1097/jes.0b013e31815ddb02
- Eckenhoff RG, Olstad CS, Carrod G (1990) Human dose-response relationship for decompression and endogenous bubble formation. *J Appl Physiol* (1985) 69(3):914–918
- Enoksen E, Shalfawi SA, Tonnessen E (2011) The effect of high- vs low-intensity training on aerobic capacity in well-trained male middle-distance runners. *J Strength Cond Res* 25(3):812–818
- Gennser M, Jurd KM, Blogg SL (2012) Pre-dive exercise and post-dive evolution of venous gas emboli. *Aviat Space Environ Med* 83(1):30–34
- Germonpre P, Pontier JM, Gempp E, Blatteau JE, Deneweth S, Lafere P, Marroni A, Balestra C (2009) Pre-dive vibration effect on bubble formation after a 30-m dive requiring a decompression stop. *Aviat Space Environ Med* 80(12):1044–1048
- Jurd KM, Thacker JC, Seddon FM, Gennser M, Loveman GA (2011) The effect of pre-dive exercise timing, intensity and mode on post-decompression venous gas emboli. *Diving Hyperb Med* 41(4):183–188
- Kessler HS, Sisson SB, Short KR (2012) The potential for high-intensity interval training to reduce cardiometabolic disease risk. *Sports Med* 42(6):489–509
- Ljubkovic M, Zanchi J, Breskovic T, Marinovic J, Lojpur M, Dujic Z (2012) Determinants of arterial gas embolism after scuba diving. *J Appl Physiol* (1985) 112(1):91–95. doi:10.1152/japophysiol.00943.2011
- Madden D, Thom SR, Milovanova TN, Yang M, Bhopale VM, Ljubkovic M, Dujic Z (2014) Exercise before SCUBA diving

- ameliorates decompression-induced neutrophil activation. *Med Sci Sports Exerc*
- Marinovic J, Ljubkovic M, Breskovic T, Gunjaca G, Obad A, Modun D, Bilopavlovic N, Tsikas D, Dujic Z (2012) Effects of successive air and nitrox dives on human vascular function. *Eur J Appl Physiol* 112(6):2131–2137
- Medby C, Bye A, Wisloff U, Brubakk AO (2008) Heat shock increases survival in rats exposed to hyperbaric pressure. *Diving Hyperb Med* 38(4):189–193
- Mollerlokken A, Breskovic T, Palada I, Valic Z, Dujic Z, Brubakk AO (2011) Observation of increased venous gas emboli after wet dives compared to dry dives. *Diving Hyperb Med* 41(3):124–128
- Thom SR, Yang M, Bhopale VM, Huang S, Milovanova TN (2011) Microparticles initiate decompression-induced neutrophil activation and subsequent vascular injuries. *J Appl Physiol* 110(2):340–351
- Thom SR, Milovanova TN, Bogush M, Bhopale VM, Yang M, Bushmann K, Pollock NW, Ljubkovic M, Denoble P, Dujic Z (2012) Microparticle production, neutrophil activation, and intravascular bubbles following open-water SCUBA diving. *J Appl Physiol* 112(8):1268–1278. doi:10.1152/jappphysiol.01305.2011
- Thom SR, Milovanova TN, Bogush M, Yang M, Bhopale VM, Pollock NW, Ljubkovic M, Denoble PJ, Madden D, Lozo M, Dujic Z (2013) Bubbles, microparticles and neutrophil activation: changes with exercise level and breathing gas during open-water SCUBA diving. *J Appl Physiol* 114(10):1396–1405
- Trappenburg MC, van Schilfgaarde M, Frerichs FC, Spronk HM, ten Cate H, de Fijter CW, Terpstra WE, Leyte A (2012) Chronic renal failure is accompanied by endothelial activation and a large increase in microparticle numbers with reduced procoagulant capacity. *Nephrol Dial Transplant* 27(4):1446–1453
- Wisloff U, Brubakk AO (2001) Aerobic endurance training reduces bubble formation and increases survival in rats exposed to hyperbaric pressure. *J Physiol* 537(Pt 2):607–611
- Yang M, Milovanova TN, Bogush M, Uzun G, Bhopale VM, Thom SR (2012a) Microparticle enlargement and altered surface proteins after air decompression are associated with inflammatory vascular injuries. *J Appl Physiol* 112(1):204–211
- Yang M, Milovanova TN, Bogush M, Uzun G, Bhopale VM, Thom SR (2012b) Microparticle enlargement and altered surface proteins after air decompression are associated with inflammatory vascular injuries. *J Appl Physiol* (1985) 112(1):204–211
- Zielinska M, Koniarek W, Goch JH, Cebula B, Tybura M, Robak T, Smolewski P (2005) Circulating endothelial microparticles in patients with acute myocardial infarction. *Kardiologia Polska* 62(6):531–542 discussion 543–534

The impact of pre-dive exercise on repetitive SCUBA diving

Dennis Madden¹, Otto Barak², Stephen R. Thom³, Ming Yang³, Veena M. Bhopale³, Marko Ljubkovic¹ and Zeljko Dujic¹

¹Department of Physiology, University of Split School of Medicine, Split, Croatia, ²Department of Physiology, University of Novi Sad, Novi Sad, Serbia and

³Department of Emergency Medicine, University of Maryland, Baltimore, MD, USA

Summary

Correspondence

Zeljko Dujic, Department of Physiology, University of Split School of Medicine, Soltanska 2, 21 000 Split, Croatia
E-mail: zeljko.dujic@mefst.hr

Accepted for publication

Received 30 May 2014;
accepted 13 October 2014

Key words

endothelial function; exercise; microparticles; repetitive; SCUBA

Aim SCUBA diving frequently involves repetitive exposures. The goal of this study was to see how exercise impacts microparticles (MPs), endothelial function and venous gas emboli (VGE) throughout multiple dives.

Methods Sixteen divers in two groups (G1 and G2) each completed six dives, three preceded by exercise (EX) and three as controls (CON). Blood for MP analysis was collected before and after each dive. VGE were monitored via transthoracic echocardiography 30, 60 and 90 min after surfacing. Exercise before diving consisted of 60-min running including eight, 3-min intervals at 90% VO_{2max} .

Results Exercise did not have a significant impact on VGE. There was no significant difference in MP counts between EX and CON. Both groups experienced a significant decrease in MP counts in the last three dives compared to the first three (G1 $P = 0.0008$, G2 $P = 0.0001$). Other indices of neutrophil/platelet interaction (dual-positive CD63/41 and CD62/41) show a significant increase ($P = 0.004$ and 0.0001) in G2.

Conclusion Both groups experienced a significant decrease in MPs at all measurements in the second series of dives compared to the first, regardless of the placement of exercise. Whether this is related to an effect of suppression of MPs or exercise timing is not clear.

Introduction

SCUBA diving in open water situations frequently involves repetitive exposures spanning multiple days for both recreational and professional divers. The risk of decompression sickness (DCS) is often associated with circulating inert gas bubbles (vascular gas emboli, VGE) resulting from decompression. Although these bubbles may be present in large quantities during DCS, their presence alone is not an indicator as high bubble loads are frequently observed following conservative dives with no clinical implications (Eftedal *et al.*, 2007). SCUBA diving results in other physiological consequences such as increased oxidative stress (Sureda *et al.*, 2012), impaired endothelial function (Obad *et al.*, 2010), platelet (Pontier *et al.*, 2012) and neutrophil (Thom *et al.*, 2012) activation, and an increase in circulating microparticles (MPs) (Thom *et al.*, 2013). While the role of these factors in DCS is not yet clear, they remain a physiological insult that may be of special interest in extreme diving circumstances or with individuals who are at a higher risk of cardiac events before they even enter the water.

Previous research has shown an increase in both number and size of circulating MPs after surfacing (Thom *et al.*, 2012,

2013; Madden *et al.*, 2014). There is evidence that these changes are related to neutrophil activation resulting in vascular leak and DCS-like symptoms in mice (Thom *et al.*, 2011). It has also been proposed that MPs with an inert gas core may serve as a nucleation site for nitrogen as it diffuses from tissues into the blood, thus contributing to bubble loads. Additionally, there is already evidence that certain parameters commonly measured following a dive, such as endothelial function and MPs which are used to quantify the stress of diving and decompression, are affected beyond 24 h after surfacing. An acclimatization has been observed demonstrating a reduction in the risk of higher VGE grades (Zanchi *et al.*, 2014), as well as changes in baseline endothelial function across multiple days of diving (Obad *et al.*, 2010).

Venous gas emboli are often used as a surrogate marker for decompression stress following exercise; however, the data on VGE and exercise are limited to a few conflicting field studies (Blatteau *et al.*, 2005; Castagna *et al.*, 2011; Madden *et al.*, 2014) and simulated dives (Dujic *et al.*, 2004; Gennser *et al.*, 2012). MPs and endothelial function show promise as other markers to assess decompression stress and these may contribute to DCS or other forms of illness with mechanisms separate from circulating gas emboli.

CE: Dhya A.	PI: Pravin Kumar
Dispatch: 29.10.14	No. of pages: 9
WILEY	
12213	Manuscript No.
C P F	Journal Code
	

1 The following study had two primary goals. First, we
 2 wanted to see whether the effect that exercise had on MP
 3 counts from our previous single dive study (Madden et al.,
 4 2014) would continue in a repetitive diving scenario. There
 5 are few MP studies that span a time course of multiple days in
 6 or out of diving research, and information of how these levels
 7 change when faced with repeated stressful events is limited.
 8 Second, we wanted to complete a comprehensive observation
 9 on the difference between repetitive dives with and without
 10 daily exercise performed before diving.

13 Materials and methods

14 Study population

15 Sixteen divers including nine males [ages (mean \pm SD)
 16 40.1 ± 7.8 years] and seven females (33.4 ± 7.4 years) with
 17 13.3 ± 8.7 years of diving experience participated in this
 18 study. Maximal oxygen consumption (VO_{2max}) for males was
 19 37.1 ± 3.8 ml kg^{-1} min^{-1} and for females 37.9 ± 6.9
 20 ml kg^{-1} min^{-1} . No subjects reported previous cases of DCS.
 21 After receiving a written explanation and an oral briefing of
 22 the methods and potential risks, all subjects gave their written
 23 informed consent. Participants were asked to abstain from
 24 alcohol consumption 24 h before diving and to maintain con-
 25 sistent eating habits throughout the duration of the study. This
 26 study was approved by the University of Split School of Medi-
 27 cine Ethics Committee, and all procedures were conducted in
 28 accordance with the Declaration of Helsinki, and the study is
 29 registered on clinicaltrials.gov (NCT02118207).

32 Exercise and control dive protocol

33 All subjects performed six dives total separated into two ses-
 34 sions each consisting of three dives spaced 24 h apart with a
 35 5-day break between the two sessions. Diving in one of these
 36 blocks (EX) was preceded daily by aerobic exercise, while the

other (CON) consisted of diving only. Diver pairs were ran-
 37 domly assigned to two groups. Group one (G1) completed
 38 the first three dives under CON conditions and the second
 39 group of three (following the 5-day rest period) under EX
 40 conditions. Group two (G2) followed the opposite protocol as
 41 displayed in Fig. 1a. Daily timing of blood collection, flow-
 42 mediated dilation (FMD), exercise (EX conditions only), div-
 43 ing and VGE analysis for CON and EX conditions is displayed
 44 in Fig. 1b,c, respectively.

45 VO_{2max} testing

46 VO_{2max} and pulmonary function testing was performed on all
 47 divers at least 7 days prior to the experiment. Before testing,
 48 height, weight and per cent body fat for each subject were
 49 determined. Body density was estimated by measurement of
 50 subcutaneous skinfold thickness with a caliper (Harpenden skin-
 51 fold caliper, Baly International, West Sussex, UK) for the calcu-
 52 lation of body composition. Pulmonary function assessment
 53 included forced vital capacity and maximal voluntary ventilation
 54 tests. The VO_{2max} test was an incremental test conducted on a
 55 treadmill as described in previous studies (Madden et al., 2014).

56 Exercise protocol

57 Subjects completed a 20-min self-selected jogging warm-up
 58 (up to 20 beats per minute below prescribed interval HR)
 59 immediately followed by 40 min of intervals (3 min with
 60 2 min active recovery repeated eight times) at an intensity
 61 corresponding with 90% of HR at VO_{2max} for a total of
 62 60 min of running. The run was conducted in a natural park
 63 on the same site as the dive location. Subjects ran on their
 64 own and controlled their effort via HR with a monitor
 65 (Garmin Forerunner 305, Garmin International, Olathe, KS,
 66 USA). Adherence to the exercise protocol was confirmed by
 67 analysing the recorded data from the HR monitor after each
 68 run with the included software (Garmin Connect).

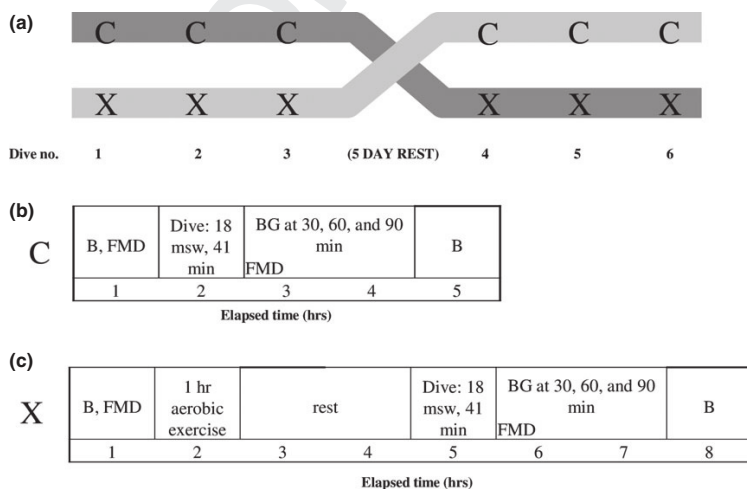

Figure 1 Study protocol. (a) Study protocol for G1 (dark-shaded track) and G2 (light-grey track). Numbers along x-axis represent dive no. C = control protocol, detailed in 1b and X = exercise protocol, detailed in 1c. Numbers along x-axis in (1b) and (c) represent elapsed time in hours.

Dive and VGE analysis

This study was performed at a military installation of the Croatian Navy Force. The dive site was located in the vicinity of the base, within a short (approximately 30 m) distance of the location where the experiments would take place. The site was chosen because of the minimal transit time between finishing the dive and beginning initial transthoracic echocardiography (TTE) analysis. All divers performed the dive at a depth of 18 m sea water (msw) with a bottom time of 41 min. This dive profile was selected with dive planning software built into Galileo dive computers (Uwatec Galileo Sol, Johnson Outdoors, Racine, WI, USA) which were also used to verify subject adherence to the dive protocol. Decompression was performed at a rate of nine msw/min, with a direct ascent to the surface. Sea temperature at the bottom was approximately 12°C, and the outside ambient temperature was approximately 20°C. Throughout the dive, divers performed swimming of subjectively moderate intensity, and HR was monitored via dive computers. Within 8–15 min after surfacing, the divers were placed in the supine position where a dual frequency (1.5–3.3 MHz) ultrasonic probe connected to a Vivid q echographic scanner (GE, Milwaukee, WI, USA) was used to obtain a clear apical 4-chamber view of the heart. VGE were monitored at 30, 60 and 90 min after surfacing, and bubble grades were recorded and graded on a scale of 0–5 with four being subdivided into 4A, 4B and 4C, according to the method described by Eftedal & Brubakk (1997), and later modified by Ljubkovic et al. (1985). In addition to monitoring bubble grade at rest, VGE were graded after two different movements, arm and leg contractions, to mobilize bubbles that may be lodged in the venous circulation.

MP materials

Blood was drawn into Cyto-Chex BCTs that contain a proprietary preservative (Streck, Inc., Medimark Europe, Grenoble, France). The volume drawn per sample was approximately 5 ml. Unless otherwise noted, chemicals were purchased from Sigma-Aldrich (St. Louis, MO, USA). Annexin binding buffer and the following agents were purchased from BD Pharmingen (San Jose, CA, USA): fluorescein isothiocyanate (FITC)-conjugated anti-Annexin V, FITC-conjugated anti-human myeloperoxidase (MPO) and R-PE-conjugated anti-human CD41 were purchased from e-Biosciences (San Diego, CA, USA), PerCP Cy5.5-conjugated anti-human CD66b from Biologend (San Diego, CA, USA) and Alexa 647-conjugated anti-human CD18 from Serotec (Raleigh, NC, USA).

Standard procedures for MPs and neutrophil acquisition and processing

Blood samples in tubes containing preservative were sent by express mail to the University of Maryland where all analyses were performed within 24 h after arrival, approximately

2–6 days from time of collection. As described previously, MPs and neutrophil characteristics remain unchanged when samples stored at either 4°C or room temperature are processed in a time span of 3 weeks from time of collection (Thom et al., 2012). All reagents and solutions used for MPs analysis were sterile and filtered (0.2 µm filter). The blood was centrifuged for 5 min at 1500 g, the supernatant was collected and combined with EDTA to achieve a concentration of 0.2 M and centrifuged at 15 000 g for 30 min. Aliquots of the 15 000 g supernatant were stained with antibodies for analysis by flow cytometry.

Flow cytometry

Flow cytometry was performed with an 8-colour, triple-laser MACSQuant (Miltenyi Biotec Corp., Auburn, CA, USA) using the manufacturers' acquisition software. Gates were set to include 0.3- to 5.0-µm particles, with exclusion of background corresponding to debris usually present in buffers. MPs were stained with annexin V and analysed as previously described, including microbeads with diameters of 0.3 µm (Sigma, Inc.), 1.0 µm, 3.0 µm and 5.0 µm (Spherotech, Inc., Lake Forest, IL, USA) to assess the size of particles. We define MPs as annexin V-positive particles with diameters up to 1 µm. Analysis of neutrophils was performed on fixed blood samples as previously described (Thom et al., 2012). Platelet activation was assessed by staining samples with CD41 antibody and annexin V in samples that included microbeads with diameters of 3.0 and 5.0 µm. Platelets were identified as particles between these microbead size limits that were CD41-positive and annexin V-negative and activation assessed as surface expression of CD63 and CD62b analogous to procedures described by others (van Velzen et al., 2012).

Endothelial function

Endothelial function was assessed by measuring FMD in response to reactive hyperaemia (Corretti et al., 2002). The subjects were allowed to rest in the supine position for a minimum of ten minutes in a quiet room prior to measurement. Measurements were performed with a Vivid q echographic scanner (GE) fitted with a 5.7- to 13.3-MHz linear probe. Images of the longitudinal brachial artery (including the lumen–intima interface on anterior and posterior walls) were stored for later analysis. Once a baseline image was obtained, arterial occlusion was created by inflating a cuff placed on the forearm to 250 mmHg for 5 min. Next, the cuff was deflated, producing a high-flow state resulting in arterial dilation. FMD was calculated as the percentage increase in brachial artery diameter from baseline to peak dilation measured after occlusion. Measurements were made with previously recorded video using Vascular Research Tools 6 software (Medical Imaging Applications-LLC, Coralville, IA, USA).

Statistics

Parametric data are expressed as mean \pm SD, and nonparametric data are expressed as median, 25th and 75th percentile. After analysis of distribution with the Shapiro–Wilk test, MP counts, platelet, and neutrophil activation were analysed by repeated-measures analysis of variance (ANOVA) followed by a Bonferroni correction. Bubble grades were analysed with the Wilcoxon signed-rank test. Comparisons between FMD% between the EX and CON protocols were made with a Student's *t*-test. Statistics were calculated using Statistica 7.0 software (Statsoft Inc, Tulsa, OK, USA).

Results

All subjects completed the full protocol. One subject, no. 209, developed type 1 DCS following the final dive and was subsequently treated in a nearby chamber for 120 min. Signs/symptoms, including self-reported fatigue along with numbness and tingling in the lower extremities and a macular rash on her torso, resolved quickly and she only required one hyperbaric oxygen recompression treatment. These symptoms were observed approximately 30 min after surfacing with a BG of 4C and no arterialization. Analysis of this subject's dive computer revealed no deviation from the planned dive parameters including depth and ascent rate. No other subjects reported any signs or symptoms of DCS.

Differences between male and female divers

Descriptive statistics for all subjects are displayed in Table 1. Of all the collected data, there were no significant differences when comparing groups strictly by sex with the exception of bubble grade (BG) as described below. As a result of this

Table 1 Anthropometric data for male and female divers.

	Male <i>n</i> = 9	Female <i>n</i> = 7	Combined <i>n</i> = 16
Age (year)	40.1 \pm 7.8	33.4 \pm 7.4	36.7 \pm 8.1
Dive exp. (year)	19.4 \pm 7.8	8.0 \pm 3.9*	13.3 \pm 8.7
Ht (cm)	182.3 \pm 1.8	166.1 \pm 5.8*	175.2 \pm 9.2
Wt (kg)	89.9 \pm 10.3	62.2 \pm 7.9*	77.8 \pm 16.9
Body fat (%)	15.1 \pm 3.2	16.5 \pm 1.2	15.7 \pm 2.7
VO _{2max} (ml kg ⁻¹ min ⁻¹)	37.1 \pm 3.8	37.9 \pm 6.9	37.5 \pm 5.3
FVC (% pred)	111.9 \pm 14.4	116.8 \pm 12.0	114.1 \pm 13.2
FEV ₁ (% pred)	112.3 \pm 13.3	112.9 \pm 9.5	112.6 \pm 11.4
FEV ₁ /FVC (% pred)	102.7 \pm 5.4	102.9 \pm 6.0	102.8 \pm 5.5

Values are means \pm SD; *n*, no. of subjects.

Pulmonary function parameters are expressed as a percentage of the predicted values (% pred) FVC, forced vital capacity; FEV₁, forced expiratory volume in 1 s; VO_{2max}, maximal O₂ uptake, determined through graded maximal treadmill test. Body fat estimated from 3-site skinfold measurements.

**P* < 0.01 compared to male subjects.

finding, male and female subjects were grouped together for data analysis of microparticles, endothelial function (FMD) and blood assays to increase statistical power.

Bubble grade

In this protocol, exercise did not have a significant impact on BG at rest for any time point in all groups. When comparing subjects strictly by sex, females, as a group, had a lower median resting BG at nearly every measured time point compared to the males (Table 2). There was no significant difference in the incidence of arterialization between G1 and G2, male and female, or EX and CON.

Endothelial function

Endothelial function was assessed through FMD and is displayed as the per cent change in peak arterial diameter before and after forearm occlusion in Fig. 2. All subjects throughout the entire protocol experienced a significant decrease in FMD

Table 2 Median bubble grade at rest 30, 60 and 90 min after surfacing.

Dive	Control dives			Exercise dives		
	1	2	3	1	2	3
30 min						
Male	3	3	3	4A	3	3
Female	1*	2*	1*	1*	2*	1*
60 min						
Male	3	3	3	4A	3	3
Female	2	3	2*	2*	2	0*
90 min						
Male	3	2	2	3	2	2
Female	1*	1*	0*	1*	1*	0*

Values represent median BG on Brubakk scale. Male and female subjects are compared within each dive, separately from assigned groups. **P* < 0.05 compared to male subjects.

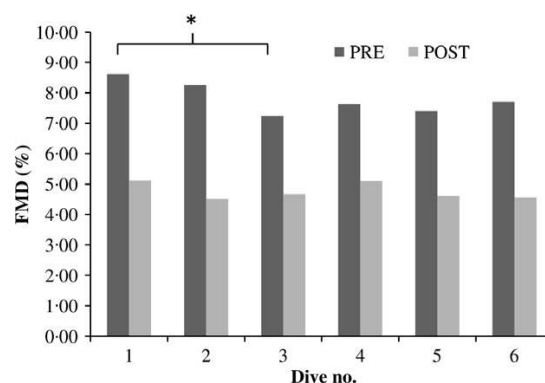

Figure 2 Flow-mediated dilation. Data show pre (dark-shaded bars) and post (light-grey bars) Δ FMD % for all divers in chronological order. **P* < 0.05 between dives 1 and 3 for all divers.

1 following diving. There was no significant difference in FMD
2 between CON and EX conditions. The pre-dive FMD values for
3 both groups were significantly lower on dive three compared to
4 dive one.

6 MP response

8 Circulating MP counts are displayed chronologically in Fig. 3a.
9 There was no significant difference in annexin V-positive MPs
10 between the two groups. Additionally, when comparing the
11 EX and CON protocol within each individual group, there was
12 no significant difference. However, both groups had significantly
13 reduced MP counts (G1 $P = 0.0008$, G2 $P = 0.0001$)
14 in the second series of dives. This reduction occurred regard-
15 less of performing the EX or CON protocol. Put another way,
16 both groups had reduced MP counts in dives four through six
17 even though they were following opposite protocols (Fig. 1).
18 There is no significant difference between the initial baseline
19 measurement of each series (1 pre and 4 pre) and the final
20 measurement (3 post 24 and 6 post 24) indicating a return to
21 baseline at the end of each series.

Platelet and neutrophil activation and interaction

Neutrophil activation was assessed as the percentage of sur-
face expression of CD18 and myeloperoxidase (MPO) on
CD66b-positive cells (Fig. 3b,c). In G1, there was no signifi-
cant difference between CON and EX conditions. In G2,
MPO% was decreased ($P = 0.001$) in dives four through six
(CON) compared to dives one through three (EX). There
was no significant change throughout the dives in both
groups in the per cent of CD66b-positive cells expressing
CD18. The expression of CD41 on CD66b-positive cells is
one potential marker for platelet–neutrophil interactions and
is displayed in Fig. 3d. As with circulating MPs, both
groups show a significant decrease in the second series of
dives compared to the first (G1 $P = 0.035$ G2 $P = 0.003$).
Platelet activation was assessed as surface expression of
CD63 and CD62P as described in Methods. The per cent of
all platelets expressing these activation-associated markers is
shown in Fig. 4a,b. Divers in G2 experienced a significant
increase in both markers (CD63, $P = 0.004$ and CD63,
 $P = 0.0001$) on the second series of dives (CON) while

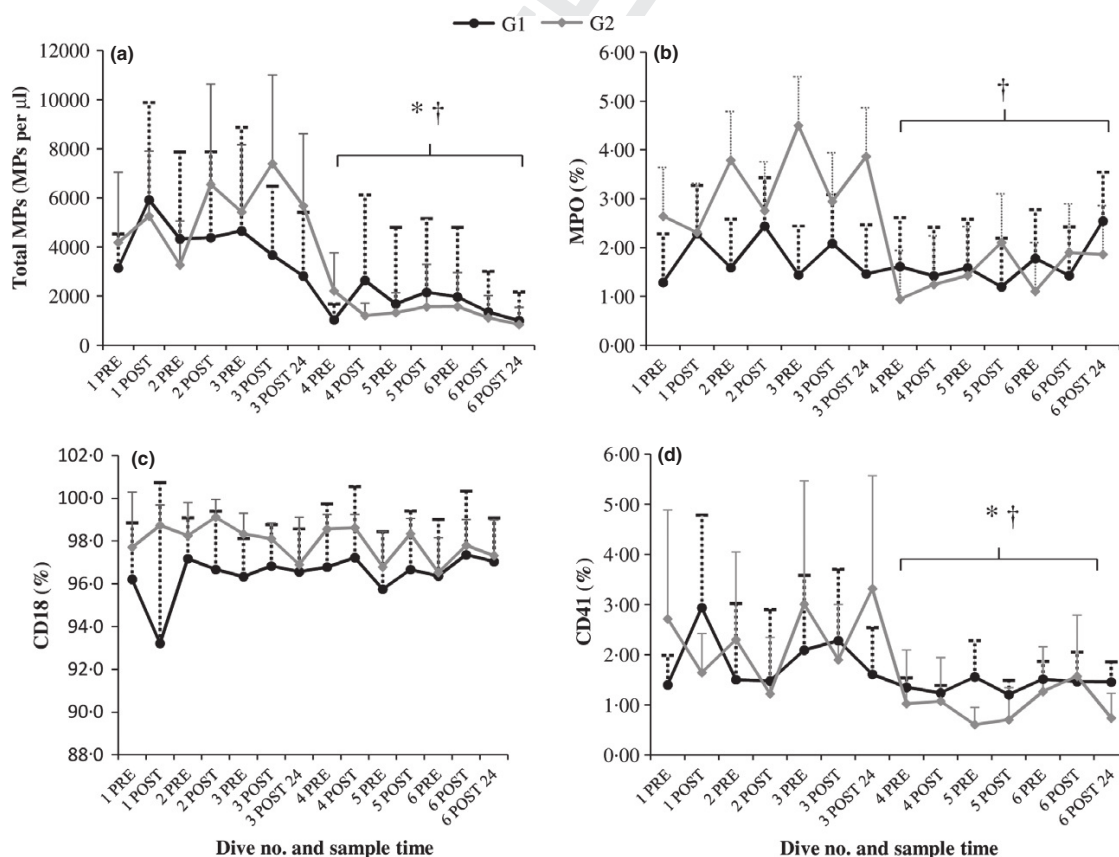

33
34
35
36
37
38
39
40
41
42
43
44
45
46
47
48
49
50
51
52
53
54
55
Figure 3 Microparticle counts, neutrophil activation and platelet interaction. Data show mean of circulating (a) MPs ($0.3\text{--}1.0\ \mu\text{m}$) μl^{-1} and neu-
trophil activation identified by CD66b staining and per cent coexpression of (b) MPO, (c) CD18 and (d) CD41. * and † $P < 0.05$ in G1 and G2 for
second series compared to the first series.

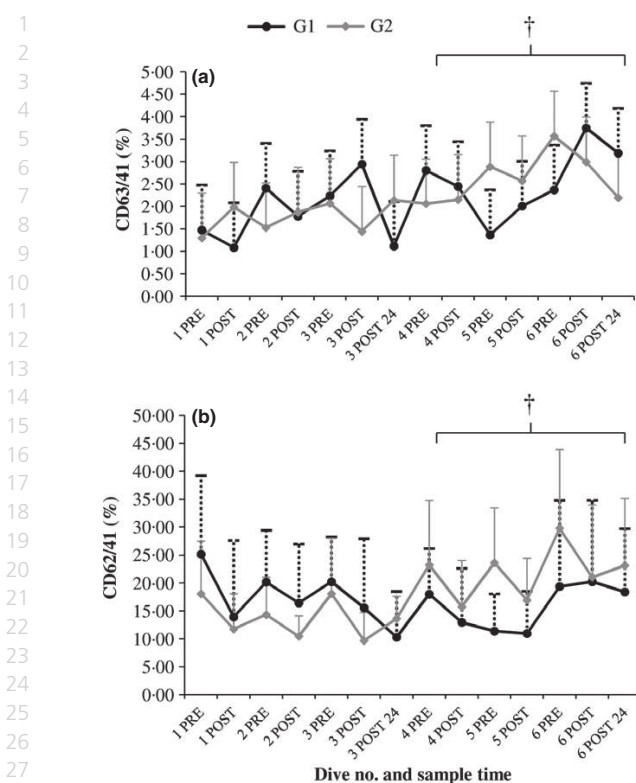

Figure 4 Platelet activation as per cent and mean fluorescence. Platelet activation shown as (a) Per cent CD41-positive MPs coexpressing the CD63 and (b) CD62 activation-associated surface proteins. † $p < 0.05$ in G2 for second series compared to the first series.

there was no significant difference between the two series in G1.

Discussion

The purpose of this study was to observe the effect of repetitive diving on MP counts, endothelial function and how exercise impacts these observations. Observations were made between male and female subjects as well. We hypothesized that aerobic exercise would influence MP measurements following SCUBA diving on a daily basis as we have previously observed (Madden et al., 2014). The actual observed pattern was different than expected, yet the results remain interesting and raise new questions on the relationship between MPs and repetitive stressful events such as diving and exercise.

Studies on the differences between male and female divers are limited. While these observations were not the primary goal of this study, the groups can provide additional data on the impact of gender on diving responses. We only observed a significant difference in BG, where the median bubble grade was lower by one grade at nearly every time point in the female group (Table 2) when compared to the males following each individual dive, which is consistent with previous

research (Boussuges et al., 2009). Interestingly, there was no significant difference in body fat percentage or VO_{2max} (Table 1) which are both parameters that would be expected to be different between these groups. These physiological characteristics have been proposed to play a role in circulating VGE due to cardiovascular fitness characteristics and the solubility of nitrogen in fat tissue (Carturan et al., 2002). However, at least one other study could not find a relationship between body fat and bubble production (Schellart et al., 2012). As both populations have a similar body fat percentage, the females could be considered relatively leaner due to differences between the distribution and absolute mass of body fat between males and females. Finally, the fact remains that these are small groups, and the female group is even smaller than the male group; one or two exceptional subjects who do not produce many bubbles could impact the median. There were no other parameters we measured that were significantly different between the male and female divers.

The statistically insignificant change in BG following the exercise dive compared to the control dive is in line with previous research using similar open sea diving protocols. The impact of exercise on VGE is positive in some studies, although none of these can be directly compared to this experiment as they utilized simulated diving (Gennser et al., 2012) or diving profiles that utilized decompressions stops (Castagna et al. 2012). One study with rats utilized a relatively extreme downhill running protocol (100 min at -16°) to induce myofibrillar damage and found no difference in bubble amounts or survival rates following a simulated dive (Jorgenson et al., 2013). Thus, conclusions that exercise *per se* reduces bubble grade may not yet be warranted until further investigation. There was no significant reduction in BG throughout the series of dives. This series was relatively short compared to one observational study (six dives compared to 60 days of military dive training, Pontier et al., 2009), and while Zanchi et al. (2014) demonstrated a reduction in risk over four dives comparing day one with day four, it is possible that the 5-day rest period between the two protocols negated any short-term protective effects.

Changes in endothelial function, as measured by FMD, occurred in line with previous research (Obad et al., 2007; Bilopavlovic et al., 2013; Lambrechts et al., 2013). Diving caused a significant reduction in FMD. While there was a trend for exercise to diminish this reduction, it was not significant. Changes in room and outdoor temperature also influence FMD (Widlansky et al., 2007), so cold water immersion may contribute to this reduction as a component of diving. In this case, the measurement was taken approximately 60 min after surfacing after the subjects had a chance to warm back up. Previous research shows a decrease in pre-dive FMD throughout a series of repetitive dives (Obad et al., 2010), and we observed this to some extent in both groups (Fig. 2) in the first series of dives, but not the second. Interestingly, as the first series includes both groups, one of them performed exercise and the other did not, yet when the protocol was

1 reversed after the 5-day rest period, the same decrease in FMD
 2 was not observed. We did not observe a relationship between
 3 MP counts and FMD, although a relationship was shown in
 4 the past when analysing MPs with endothelial surface markers
 5 (Christmas *et al.*, 2010), which we did not include in this
 6 study.

7 To our knowledge, this is the first study to examine MPs
 8 over this length of time. Related to overall MP counts, the first
 9 dive follows what we have observed in our previous research;
 10 an attenuation of MP release following a dive preceded by
 11 exercise compared to a control dive (approximately
 12 $1000 \mu\text{l}^{-1}$ increase following EX and $2500 \mu\text{l}^{-1}$ following
 13 CON). The most overt observation is that both groups experi-
 14 ence a significant decrease at all measurements in the second
 15 series of dives compared to the first, regardless of the place-
 16 ment of exercise. At this time, there is not enough informa-
 17 tion to determine whether this is related to suppression of MP
 18 release or an increased clearance. The final measurement (6
 19 post 24) was significantly lower than the initial pre-dive mea-
 20 surement (1 pre, serving as a baseline), which had taken place
 21 before any exercise or diving, in both G1 and G2 ($P = 0.001$
 22 and 0.008). Furthermore, while MPs have been linked to DCS
 23 in mice (Thom *et al.*, 2011), and to the pathogenesis of cer-
 24 tain diseases in humans (Anderson *et al.*, 2010), there are not
 25 enough data on the normal baseline values and the natural
 26 day-to-day variability in MP counts to indicate whether this
 27 decrease is a positive or negative event. Subject 209, who was
 28 treated for type 1 DCS, followed the same pattern as in Fig. 3a
 29 with the exception of the '6 pre' measurement, taken before
 30 exercise and diving on the day the DCS was reported, which
 31 was elevated approximately tenfold over the previous mea-
 32 surement. There were no significant changes in indicators of
 33 platelet and neutrophil activation compared to this subjects
 34 15 previous symptom-free dives. The subject's blood was sam-
 35 pled again before she entered the chamber, and the MP counts
 36 had returned back to the baseline value from the day before,
 37 prior to the extreme elevation.

38 It is possible that the cumulative effect of exercise may have
 39 contributed to increased global stress experienced by the
 40 divers. SCUBA diving on its own increases MPs of various sub-
 41 types (Vince *et al.*, 2009; Madden *et al.*, 2010; Thom *et al.*,
 42 2013). The increase in annexin V-positive MPs following
 43 aerobic exercise has been observed in a few studies (Mobius-
 44 Winkler *et al.*, 2009; Sossdorf *et al.*, 2011), including our
 45 previous exercise and diving studies (Madden *et al.*, 2014).
 46 These studies show an acute increase following a single bout
 47 with a return to baseline 2–24 h later depending on the mode
 48 and duration of exercise. However, none of these sources
 49 included blood sampling beyond 24 h, and it is clear in this
 50 case that there are cumulative effects in G2 divers who com-
 51 pleted the EX protocol first (Fig. 3a). Long-term studies show
 52 an adaptation in military divers following 3 months of train-
 53 ing (physical and diving) resulting in decreased VGE and a
 54 proposed acclimatization to diving (Pontier *et al.*, 2009).
 55 Participants completed a mean of 67 dives over 90 days,

which is a comparable density to the present study although
 the overall load is much smaller. It is possible that the increase
 of decompression stress first results in negative changes before
 the body can respond and adapt, as in the general adaptation
 syndrome, and the present study represents the stimulus nec-
 essary to encourage adaptation.

Markers for platelet and neutrophil activation are less clear.
 The percentage of CD66b-positive cells expressing increased
 surface MPO decreases significantly for G2 in the second ser-
 ies, yet remains more consistent for G1. The percentage of
 CD66b-positive cells expressing increased surface CD18
 remains more consistent throughout the entire series in both
 groups. Platelet and neutrophil interactions, which were corre-
 lated with DCS in mice (Thom *et al.*, 2011; Yang *et al.*, 2012)
 and are measured as the percentage of neutrophils exhibiting
 the platelet-specific surface marker CD41, were also decreased
 during the second series of dives in both groups. Similar to
 MPO, markers of platelet activation (Fig. 4a,b) increase signif-
 icantly in the second series of dives in G2 only.

There is not yet enough information to determine whether
 MP release and clearance have any acute or chronic conse-
 quences. The appearance and action of MPs are more complex
 than to simply use it as a biomarker of negative consequences,
 and the role of MPs may be related, in part, to their composi-
 tion. While neutrophil and platelet-derived MPs are associated
 with vascular injury, coagulation and inflammation, endothe-
 lial-derived MPs may play a role in maintaining vascular homeo-
 stasis and angiogenesis (Dignat-George & Boulanger, 2011).

In conclusion, we have demonstrated that different param-
 eters associated with DCS may follow individual time courses.
 Additionally, this is the first study to examine the MP response
 to repeated activities over multiple days. Future research could
 investigate whether this depression is related to other stress
 markers such as salivary cortisol or heart rate variability,
 which is altered during some dive conditions (Flouris & Scott,
 2009). The observation that MPs, which may play a role in
 decompression injury, remain altered after 5 days of rest may
 be of interest to divers who are diving frequently over short
 periods of time. DCS is traditionally viewed as a consequence
 of circulating gas bubbles, but it is possible there are other
 mechanisms, such as endothelial dysfunction (Madden &
 Laden, 2009) or neutrophil activation that act concurrently
 and perhaps even independently to contribute to decompres-
 sion-related illness.

Perspective

While a few studies alone are not enough to alter diving pro-
 cedures, there are a few points of interest that could be useful
 for those who practice diving medicine, as well as individual
 divers. Exercise and SCUBA diving have a complex interaction,
 and the same could be said about any other sources of stress
 such as fatigue, sleep, nutritional, or health status, and envi-
 ronmental conditions. These are all variables that could impact
 an individual's ability to handle decompression, and yet, at

1 this time, they are given very little consideration in standard
 2 diving procedures. It is not as simple as placing an interven-
 3 tion, such as exercise, in a category of protective or detrimen-
 4 tal when many other variables can impact that relationship.
 5 However, mechanisms uncovered by isolated studies such as
 6 these combined with observational and epidemiological data
 7 are necessary to improve the safety and efficacy of decompres-
 8 sion procedures.

11 Acknowledgments

12 The authors wish to thank Ivana Banic, Robert Kramaric and
 13 Nada Bilopavlovic for their extraordinary contributions to this
 14 study.

17 References

19 Anderson HC, Mulhall D, Garimella R. Role
 20 of extracellular membrane vesicles in the
 21 pathogenesis of various diseases, includ-
 22 ing cancer, renal diseases, atherosclerosis,
 23 and arthritis. *Lab Invest* (2010); **90**: 1549–
 24 1557.
 25 Bilopavlovic N, Marinovic J, Ljubkovic M,
 26 Obad A, Zanchi J, Pollock NW, Denoble P,
 27 Dujic Z. Effect of repetitive SCUBA diving
 28 on humoral markers of endothelial and cen-
 29 tral nervous system integrity. *Eur J Appl Physiol*
 30 (2013); **113**: 1737–1743.
 31 Blatteau JE, Gempp E, Galland FM, Pontier
 32 JM, Sainty JM, Robinet C. Aerobic exercise
 33 2 hours before a dive to 30 msw decreases
 34 bubble formation after decompression. *Aviat
 35 Space Environ Med* (2005); **76**: 666–669.
 36 Boussuges A, Retali G, Bodere-Melin M, Gar-
 37 dette B, Carturan D. Gender differences in
 38 circulating bubble production after SCUBA
 39 diving. *Clin Physiol Funct Imaging* (2009); **29**:
 40 400–405.
 41 Carturan D, Boussuges A, Vanuxem P, Bar-
 42 hen A, Burnet H, Gardette B. Ascent rate,
 43 age, maximal oxygen uptake, adiposity, and
 44 circulating venous bubbles after diving. *J
 45 Appl Physiol* (2002); **93**: 1349–1356.
 46 Castagna O, Brisswalter J, Vallee N, Blatteau
 47 JE. Endurance exercise immediately before
 48 sea diving reduces bubble formation in
 49 scuba divers. *Eur J Appl Physiol* (2011); **111**:
 50 1047–1054.
 51 Christmas BC, Midgley AW, Taylor L, Vince
 52 RV, Laden G, Madden LA. Acute antioxidant
 53 pre-treatment attenuates endothelial micro-
 54 particle release after decompression. *Diving
 55 Hyperb Med* (2010); **40**: 184–188.
 Corretti MC, Anderson TJ, Benjamin EJ, Celer-
 majer D, Charbonneau F, Creager MA,
 Deanfield J, Drexler H, Gerhard-Herman M,
 Herrington D, Vallance P, Vita J, Vogel R.
 International Brachial Artery Reactivity Task

F. Guidelines for the ultrasound assessment
 of endothelial-dependent flow-mediated
 vasodilation of the brachial artery: a report
 of the International Brachial Artery Reactiv-
 ity Task Force. *J Am Coll Cardiol* (2002); **39**:
 257–265.
 Dignat-George F, Boulanger CM. The many
 faces of endothelial microparticles. *Arterioscler
 Thromb Vasc Biol* (2011); **31**: 27–33.
 Dujic Z, Duplancic D, Marinovic-Terzic I,
 Bakovic D, Ivancev V, Valic Z, Eterovic D,
 Petri NM, Wisloff U, Brubakk AO. Aerobic
 exercise before diving reduces venous gas
 bubble formation in humans. *J Physiol*
 (2004); **555**: 637–642.
 Eftedal O, Brubakk AO. Agreement between
 trained and untrained observers in grading
 intravascular bubble signals in ultrasonic
 images. *Undersea Hyperb Med* (1997); **24**:
 293–299.
 Eftedal OS, Lydersen S, Brubakk AO. The rela-
 tionship between venous gas bubbles and
 adverse effects of decompression after air
 dives. *Undersea Hyperb Med* (2007); **34**: 99–
 105.
 Flouris AD, Scott JM. Heart rate variability
 responses to a psychologically challenging
 scuba dive. *J Sports Med Phys Fitness* (2009);
49: 382–386.
 Gemner M, Jurd KM, Blogg SL. Pre-dive exer-
 cise and post-dive evolution of venous gas
 emboli. *Aviat Space Environ Med* (2012); **83**:
 30–34.
 Jorgenson A, Foster PP, Eftedal I, Wisloff U,
 Paulson G, Havnes MB, Brubakk AO. Exer-
 cise-induced myofibrillar disruption with
 sarcolemmal integrity prior to simulated
 diving has no effect on vascular bubble for-
 mation in rats. *Eur J Appl Physiol* (2013);
113: 1189–1198.
 Lambrechts K, Pontier JM, Balestra C, Mazur
 A, Wang Q, Buzzacott P, Theron M,

Mansourati J, Guerrero F. Effect of a single,
 open-sea, air scuba dive on human micro-
 and macrovascular function. *Eur J Appl Physiol*
 (2013); **113**: 2637–2645.
 Ljubkovic M, Zanchi J, Breskovic T, Marinovic
 J, Lojpur M, Dujic Z. Determinants of arte-
 rial gas embolism after scuba diving. *J Appl
 Physiol* (1985); **112**: 91–95.
 Madden LA, Laden G. Gas bubbles may not
 be the underlying cause of decompression
 illness - The at-depth endothelial dysfunc-
 tion hypothesis. *Med Hypotheses* (2009); **72**:
 389–392.
 Madden LA, Christmas BC, Mellor D, Vince
 RV, Midgley AW, McNaughton LR, Atkin
 SL, Laden G. Endothelial function and stress
 response after simulated dives to 18 msw
 breathing air or oxygen. *Aviat Space Environ
 Med* (2010); **81**: 41–45.
 Madden D, Thom SR, Milovanova TN, Yang
 M, Bhopale VM, Ljubkovic M, Dujic Z.
 Exercise before SCUBA Diving Ameliorates
 Decompression-Induced Neutrophil Activa-
 tion. *Med Sci Sports Exerc* (2014); **???**: ???–???.
 Mobius-Winkler S, Hilberg T, Menzel K,
 Golla E, Burman A, Schuler G, Adams V.
 Time-dependent mobilization of circulating
 progenitor cells during strenuous exercise
 in healthy individuals. *J Appl Physiol* (2009);
107: 1943–1950.
 Obad A, Valic Z, Palada I, Brubakk AO, Mo-
 dun D, Dujic Z. Antioxidant pretreatment
 and reduced arterial endothelial dysfunction
 after diving. *Aviat Space Environ Med* (2007);
78: 1114–1120.
 Obad A, Marinovic J, Ljubkovic M, Breskovic
 T, Modun D, Boban M, Dujic Z. Successive
 deep dives impair endothelial function and
 enhance oxidative stress in man. *Clin Physiol
 Funct Imaging* (2010); **30**: 432–438.
 Pontier JM, Guerrero F, Castagna O. Bubble
 formation and endothelial function before

Conflict of interest

The authors declare no conflict of interest.

Funding

The research leading to these results has received funding from the People Programme (Marie Curie Actions) of the European Union's Seventh Framework Programme FRP/2007-2013/under REA grant agreement no. 264816, NEWFELPRO fellowship project of the Government of the Republic of Croatia and the Ministry of Science, Education and Sport, grant agreement no. 11, and the US Office of Naval Research Grant no. N00014-13-10614

- 1 and after 3 months of dive training. *Aviat*
 2 *Space Environ Med* (2009); **80**: 15–19.
- 3 Pontier JM, Gempp E, Ignatescu M. Blood
 4 platelet-derived microparticles release and
 5 bubble formation after an open-sea air dive.
 6 *Appl Physiol Nutr Metab* (2012); **37**: 888–892.
- 7 Schellart NA, Vellinga TP, van Dijk FJ, Sterk
 8 W. Doppler bubble grades after diving and
 9 relevance of body fat. *Aviat Space Environ Med*
 10 (2012); **83**: 951–957.
- 11 Sossdorf M, Otto GP, Claus RA, Gabriel HH,
 12 Losche W. Cell-derived microparticles pro-
 13 mote coagulation after moderate exercise.
 14 *Med Sci Sports Exerc* (2011); **43**: 1169–1176.
- 15 Sureda A, Batle JM, Ferrer MD, Mestre-Alfaro
 16 A, Tur JA, Pons A. Scuba diving activates
 17 vascular antioxidant system. *Int J Sports Med*
 18 (2012); **33**: 531–536.
- 19 Thom SR, Yang M, Bhopale VM, Huang S,
 20 Milovanova TN. Microparticles initiate
 21 decompression-induced neutrophil activa-
 22 tion and subsequent vascular injuries. *J Appl*
 23 *Physiol* (2011); **110**: 340–351.
- 24 Thom SR, Milovanova TN, Bogush M,
 25 Bhopale VM, Yang M, Bushmann K,
 26 Pollock NW, Ljubkovic M, Denoble P,
 27 Dujic Z. Microparticle production,
 28 neutrophil activation, and intravascular
 29 bubbles following open-water SCUBA div-
 30 ing. *J Appl Physiol* (2012); **112**: 1268–
 31 1278.
- 32 Thom SR, Milovanova TN, Bogush M, Yang
 33 M, Bhopale VM, Pollock NW, Ljubkovic
 34 M, Denoble PJ, Madden D, Lozo M, Dujic
 35 Z. Bubbles, microparticles and neutrophil
 36 activation: changes with exercise level
 37 and breathing gas during open-water
 38 SCUBA diving. *J Appl Physiol* (2013);
 39 ???-???
- 40 van Velzen JF, Laros-van Gorkom BA, Pop
 41 GA, van Heerde WL. Multicolor flow
 42 cytometry for evaluation of platelet surface
 43 antigens and activation markers. *Thromb Res*
 44 (2012); **130**: 92–98.
- 45 Vince RV, McNaughton LR, Taylor L, Midgley
 46 AW, Laden G, Madden LA. Release of
 47 VCAM-1 associated endothelial microparticles
 48 following simulated SCUBA dives. *Eur J Appl*
 49 *Physiol* (2009); **105**: 507–513.
- 50 Widlansky ME, Vita JA, Keyes MJ, Larson
 51 MG, Manburg NM, Levy D, Mitchell GF,
 52 Osypiuk EW, Vasani RS, Benjamin EJ. Rela-
 53 tion of season and temperature to endothe-
 54 lium-dependent flow-mediated vasodilation
 55 in subjects without clinical evidence of car-
 diovascular disease (from the Framingham
 Heart Study). *Am J Cardiol* (2007); **100**:
 518–523.
- Yang M, Milovanova TN, Bogush M, Uzun G,
 Bhopale VM, Thom SR. Microparticle
 enlargement and altered surface proteins
 after air decompression are associated with
 inflammatory vascular injuries. *J Appl Physiol*
 (2012); **112**: 204–211.
- Zanchi J, Ljubkovic M, Denoble PJ, Dujic Z,
 Ranapurwala S, Pollock NW. Influence of
 Repeated Daily Diving on Decompression
 Stress. *Int J Sports Med* (2014); **35**: 465–
 468.

Exercise after SCUBA diving increases the incidence of arterial gas embolism

Dennis Madden, Mislav Lozo, Zeljko Dujic, and Marko Ljubkovic

Department of Physiology, University of Split School of Medicine, Split, Croatia

Submitted 10 January 2013; accepted in final form 7 June 2013

Madden D, Lozo M, Dujic Z, Ljubkovic M. Exercise after SCUBA diving increases the incidence of arterial gas embolism. *J Appl Physiol* 115: 716–722, 2013. First published June 13, 2013; doi:10.1152/jappphysiol.00029.2013.—Arterialization of gas bubbles after decompression from scuba diving has traditionally been associated with pulmonary barotraumas or cardiac defects, such as the patent foramen ovale. Recent studies have demonstrated the right-to-left passage of bubbles through intrapulmonary arterial-venous anastomoses (IPAVA) that allow blood to bypass the pulmonary microcirculation. These passages open up during exercise, and the aim of this study is to see if exercise in a postdiving period increases the incidence of arterialization. After completing a dive to 18 m for 47 min, patent foramen ovale-negative subjects were monitored via transthoracic echocardiography, within 10 min after surfacing, for bubble score at rest. Subjects then completed an incremental cycle ergometry test to exhaustion under continuous transthoracic echocardiography observation. Exercise was suspended if arterialization was observed and resumed when the arterialization cleared. If arterialization was observed a second time, exercise was terminated, and oxygen was administered. Out of 23 subjects, 3 arterialized at rest, 12 arterialized with exercise, and 8 did not arterialize at all even during maximal exercise. The time for arterialization to clear with oxygen was significantly shorter than without. Exercise after diving increased the incidence of arterialization from 13% at rest to 52%. This study shows that individuals are capable of arterializing through IPAVA, and that the intensity at which these open varies by individual. Basic activities associated with SCUBA diving, such as surface swimming or walking with heavy equipment, may be enough to allow the passage of venous gas emboli through IPAVA.

SCUBA diving; exercise; VGE; arterialization; IPAVA

VENOUS GAS EMBOLI (VGE) ARE a common occurrence during decompression from SCUBA diving and are normally trapped and eliminated by the pulmonary microcirculation. Arterialization of these emboli is usually associated with septal wall defects in the heart, such as a patent foramen ovale (PFO) (26), that allow the emboli to cross over from the right to the left side of the circulation. Arterialization may also occur in individuals who do not possess PFO, when the quantity of VGE overwhelms the ability of the pulmonary circuit to trap and eliminate these bubbles (4). Investigations of arterialization at rest show incident rates to range from 13 to 26% (11, 16, 18). Recent studies have used contrast bubbles to investigate intrapulmonary arterial-venous anastomoses (IPAVA) that allow blood to bypass the pulmonary microcirculation (24). These vascular pathways allow the passage of contrast bubbles from the venous to arterial circulation in laboratory conditions during exercise (9, 13), and we hypothesize that these vascular pathways provide the path for arterialization of VGE in divers in the field.

Address for reprint requests and other correspondence: M. Ljubkovic, Dept. of Physiology, Univ. of Split School of Medicine, Soltanska 2, 21 000 Split, Croatia (e-mail: marko.ljubkovic@mefst.hr).

Although the exact physiological role of IPAVA is not yet clear, recent studies have found that they open during physical activity and may serve to help regulate pulmonary arterial pressure (20, 24). The intensity of $\dot{V}O_2$ uptake ($\dot{V}O_2$) consumption at which this occurs is variable, ranging from rest to maximal effort, with few subjects not showing any evidence of opening at all (9). IPAVA are larger in diameter than the surrounding pulmonary microcirculation and may allow the easier passage of bubbles that would normally be trapped and eliminated. Stickland et al. (24) and Eldridge et al. (9) were the first to use injected contrast bubbles during exercise in PFO negative subjects to demonstrate this passage. Further studies have shown that the use of supplemental oxygen during exercise can prevent the opening of these shunts (21). Supplemental oxygen is currently a recommended first aid treatment for divers experiencing symptoms of decompression sickness (DCS) (19). Any additional information on the relationship between arterialization, IPAVA, and oxygen supplementation may provide guidelines and protocol for prophylactic use of oxygen in certain scenarios.

Multiple diving studies have produced the arterialization of emboli without any reported incidence of DCS or other related acute symptoms. However, PFO and arterializations still remain linked to neurological symptoms of DCS (10, 23, 27, 28) and chronic cerebral microvascular damage (15). These relationships warrant the continued investigation of the physiological conditions that lead to arterialization.

Therefore, the purpose of this study is to explore the impact of exercise in a postdive period on potential VGE arterialization. Furthermore, the effect of oxygen administration in the subject exhibiting the VGE passage to systemic circulation was also investigated.

METHODS

This study received approval from the University of Split Medical School Ethics Committee, and each subject gave written, informed consent before participation. All studies were performed in accordance with the Declaration of Helsinki.

Subjects. Twenty-three subjects (20 men and 3 women), age range of 23–65 yr, participated in the study. Diving experience of the subjects ranged from 2 to 41 yr (mean 19.25 ± 12.23 yr). Subjects selected have either been tested negative for PFO within the past 3 yr or were screened before participation in the study. PFO screening was conducted by an anesthesiologist using preestablished procedures (18). Twenty-five subjects volunteered for the study, 2 were excluded due to a positive PFO test, and 23 subjects completed the protocol. Pulmonary function, cycle ergometry, and anthropometric data are presented in Table 1. All subjects were apparently healthy and were cleared to dive at the time of the study, and there were no reports of illness during the duration of protocol.

Pulmonary function and maximum $\dot{V}O_2$ testing. Maximum $\dot{V}O_2$ ($\dot{V}O_{2max}$) and pulmonary function testing was performed by all divers at least 3 days before the diving experiment. Before testing, height, weight, and percent body fat for each subject were determined. Percent body fat was estimated by measurement of subcutaneous skin

Table 1. Anthropometric data for male and female divers

Parameter	Male (n = 20)	%Predicted	Female (n = 3)	%Predicted
Age, yr	40.7 ± 12.0		38.3 ± 5.0	
Height, cm	182.0 ± 6.0		168.0 ± 1.0	
Weight, kg	93.6 ± 10.0		58.0 ± 5.6	
FVC, liter	5.6 ± 0.8	110.5 ± 14.7	3.9 ± 0.3	110.6 ± 9.2
FEV ₁ , liter	4.3 ± 0.5	106.6 ± 13.6	3.3 ± 0.3	108.5 ± 12.4
FEV ₁ /FVC, %	78.7 ± 7.8	98.9 ± 9.6	84.8 ± 4.3	103.7 ± 6.2
MVV, l/min	172.5 ± 25.4	121.9 ± 25.4	126.4 ± 13.9	114.7 ± 15.9
$\dot{V}O_{2max}$, ml·kg ⁻¹ ·min ⁻¹	43.5 ± 7.3		47.0 ± 4.6	
$\dot{V}O_{2max}$ power, W	257.3 ± 37.1		175.0 ± 4.3	

Values are means ± SD; n, no. of subjects. FVC, forced vital capacity; FEV₁, forced expiratory volume in 1 s; MVV, maximal voluntary ventilation; $\dot{V}O_{2max}$, maximum O₂ uptake, determined through graded maximal cycle ergometry test. Power (in Watts) is of last completed stage of cycle ergometer test.

fold thickness with a caliper (Harpden skinfold caliper, Baty International, West Sussex, UK) at the three sites, as dictated by the Jackson Pollock equations for male and female subjects. Pulmonary function assessment included forced vital capacity and maximal voluntary ventilation tests. The $\dot{V}O_{2max}$ test was an incremental test conducted on a cycle ergometer (Marquette Hellige Medical Systems 900 ERG, Milwaukee, WI), beginning at 50 (for female subjects) or 80 W (male subjects) and increasing 15 W every minute until voluntary termination or until at least two of the three following requirements were met: 1) a plateau of $\dot{V}O_2$ (<150 ml increase) with an increase in workload; 2) respiratory exchange ratio > 1.1; and 3) heart rate (HR) in excess of 90% of age predicted (220 – age) values. Once these criteria were met, the highest recorded $\dot{V}O_2$ was selected as the subject's maximal value. The ergometer has been modified to stabilize the torso to aid in transthoracic contrast echocardiography (TTE) imaging and was used in the field data collection portion of the study. Performing the test on this equipment allowed the subjects to familiarize themselves with equipment that would be used in the future. Briefly, the modifications consisted of a backboard fixed to the base of the ergometer that would provide a surface for the subjects to brace their back against in a 90° upright position. The bicycle's handlebars were lengthened to accommodate this new position and provide leverage for the cyclists to press their back into the board. This action, combined with straps, greatly reduced movement in the upper body during intense pedaling. Additionally, a support was made to hold the left arm in a 90° abducted and externally rotated position with a 90° bend at the elbow to open up the intercostal space for a better TTE window.

Diving protocol and location. This study was performed at a military installation of the Croatian Navy Force. The dive site was located in the vicinity of the base, within a short (~30 m) distance of the location where the experiments would take place. The site was chosen because of the minimal transit time between finishing the dive and beginning initial TTE analysis. All divers performed the dive at a depth of 18 m sea water (msw) with a 47-min bottom time. Decompression was performed at a rate of 9 msw/min, with direct ascent to the surface. Sea temperature at the bottom was ~16°C, and the outside temperature was ~26°C. Throughout the dive, divers performed swimming of moderate intensity.

Postdive exercise and echocardiography. Within 8–15 min after surfacing, the divers were placed in the supine position where an ultrasonic probe connected to a Vivid q echographic scanner (GE, Milwaukee, WI) was used to obtain a clear apical four-chamber view of the heart. This position was monitored continuously until 30 min postsurfacing, and initial bubble images were recorded and scored on a scale of 0 to 5, with 4 being subdivided into 4A, 4B, and 4C, according to the method described by Eftedal and Brubakk (8), and later modified by Ljubkovic et al. (16). Next the subject was moved to a seating position where a bubble score was obtained again after approximately 2–3 min to observe the effect of the posture change on the bubble score. The subject then continued on

with one of two potential procedures based on the observation at rest in the supine position. If arterialization was observed in the supine position, defined by an agreement on two trained observers of the appearance of bubbles in the left heart, the subject completed the supine oxygen protocol (O₂) as described below. If the subjects displayed no arterialization, they advanced to the exercise protocol also described below.

O₂ protocol. In the supine position, the subject was continuously monitored in the apical four-chamber view via TTE by two experienced observers. O₂ (99.5%) was administered through a mouthpiece, while the subject wore nose clips. With a continuously running timer, the time was marked when there was no longer any observed arterialization, as defined by 20 consecutive cardiac cycles with no bubbles in the left heart. At this time, the subject was switched from O₂ to breathing room air. The next recorded time interval was when bubbles were again observed in the left heart, after being taken off of O₂. The final time interval was recorded when no more arterializations were observed.

Exercise protocol. After it was determined that a subject was not arterializing at rest, they were moved to an electronically braked cycle ergometer in an upright position. The torso was strapped into the support device as described above, and the left arm was moved into the abducted and externally rotated position. When a clear picture of the heart was obtained, the subject began the exercise procedure. The subjects completed a single incremental exercise test with a starting workload of 60 W and a 30-W increases every 2 min. After beginning exercise, on the first appearance of bubbles in the left heart (in divers in whom the arterialization was observed), the exercise was immediately suspended while TTE observation of the heart continued. The time was noted both when the bubbles first appeared in the left heart and when the left heart was clear of bubbles. The criterion for clearance of the bubbles was 20 consecutive cardiac cycles without appearance of bubbles in the left heart. This observation was used as an estimation of when, and at what workload, pulmonary shunting had occurred. Once the left heart was clear of bubbles, exercise was resumed at the same intensity from which it was suspended when the shunting occurred. The subjects continued with the protocol until bubbles were again observed in the left heart. At this second occurrence of arterialization, exercise was terminated, and oxygen at a concentration of 99.5% O₂ was immediately given. The time interval of the appearance and clearing of the bubbles was again recorded as before: the only difference was the use of O₂. For individuals who did not arterialize, the protocol was terminated when subjects could no longer maintain consistent power output. Expired gasses and HR were monitored and recorded during the initial $\dot{V}O_{2max}$ test and during the exercise protocols after diving via a portable metabolic system (Cosmed K4 B², Rome, Italy).

Oxygen subgroup. On a separate occasion, an additional subgroup of six divers, selected from the group of those who arterialized during exercise, completed a second dive. The goal of this dive was to see how, and on what schedule, VGE react to the

Table 2. Subjects who arterialized at rest

Subject No.	Age, yr	Sex	Initial Bubble Score Cardiac Chamber		Upright Bubble Score Cardiac Chamber		Time After Surfacing, min:s			
			R	L	R	L	O ₂ given	L chambers clear*	Arterialization resumes	L chambers clear
1	23	M	4B	2	3	0	25:52	26:55	29:51	51:41
2	23	M	4C	3	4C	3	10:47	11:58	12:26	46:35
3	44	M	4A	2	3	0	21:14	21:44	23:09	37:00

M, male; R, right cardiac chambers; L, left cardiac chambers. *No bubbles observed in L cardiac chambers.

administration of oxygen at rest after diving. After completing a dive of the same profile (18 msw, 47 min bottom time), divers preceded directly to the field laboratory for imaging. In the supine position, divers were given oxygen 30 min after surfacing, to match both the timing of the procedure, as well as peak bubble production, while under continuous TTE observation. Oxygen was given at 12 l/min for 20 min, and bubble score was recorded at 2-min intervals.

Statistical analysis. An independent samples *t*-test was used to compare the time of exercise after surfacing in the group that arterialized during exercise with the group that did not. A paired samples *t*-test was used to compare the time for arterialization to stop while breathing room air and while breathing oxygen in the exercise group. The supine and upright bubble score at rest of those two groups, as well as the oxygen subgroup was compared with a Mann-Whitney test.

RESULTS

Data obtained after the dive, exercise, and oxygen protocols are presented in Table 2. All subjects completed the dive as planned without showing any signs or symptoms of DCS or any other adverse effects. In *subjects 1–3*, we detected gas bubbles in both the right and left sides of the heart at rest. These divers then completed the oxygen protocol. *Subjects 4–23* displayed a range of emboli (bubble score 0–4B) in the right heart at rest, but without apparent arterialization, and advanced to the exercise protocol. *Subjects 4–15* displayed arterialization at some point during exercise to $\dot{V}O_{2max}$ (Table 3), while in *subjects 16–23* we did not observe arterialization at any point during the study (Table 4).

Oxygen protocol. Subjects who displayed arterialization at rest were given oxygen while under continuous observation via TTE in the supine position. The time between the first

observation of arterialization and the application of O₂ ranged between 2 and 7 min. This includes the time to monitor the heart in the upright position, and the relatively wide range of time is the result of the extra time associated with obtaining a new cardiac window with the TTE probe, which varied in difficulty from subject to subject. When oxygen was applied, arterialization was no longer observed in any of the divers, with the mean time of 55 ± 22 s. After the left heart was clear of bubbles, and the subjects were switched back to room air, the arterialization resumed in all divers, within 96 ± 75 s. After arterialization was confirmed, the mean time for emboli in the left heart to clear, while breathing room air, was $1,397 \pm 614$ s.

Exercise protocol. The exercise intensity, as $\% \dot{V}O_{2max}$, at which arterialization was first observed in *subjects 4–23* is displayed in Fig. 1. Once arterialization was observed and exercise suspended, the mean time until the left heart was clear of emboli was 88 ± 41 s. Exercise was then resumed at the same intensity at which it was suspended. During the second round of exercise, supplemental O₂ (99.5%) was given once arterialization was observed and exercise was suspended. The $\% \dot{V}O_{2max}$ that elicited arterialization in the second round was variable within individuals. However, the workload in Watts at the time of the observed arterializations was equal in 9 of 10 subjects who arterialized in both rounds of exercise. The mean time until the left heart was clear of emboli was 46 ± 15 s. *Subjects 4* and *6* did not produce any observable emboli in the left heart during the second round of exercise.

Oxygen subgroup. Oxygen administration at rest reduced VGE over 20 min. Immediately after the application, there was

Table 3. Conditions in which subjects arterialized during exercise

Subject No.	Subject No. Prior Study	Age, yr	Sex	Initial BS†		Upright BS		First Exercise Arterialization BS							Second Exercise Arterialization BS						
				R	L	R	L	Time of ex onset	Time of art	R	L	$\dot{V}O_{2max}$, %	Power, W	Time to clear‡	Time of ex resume	Time of 2nd art	R	L	$\dot{V}O_{2max}$, %	Power, W	Time to clear with O ₂ §
4	30	65	M	1	0	0	0	36:23	42:57	3	1	81	150	01:23	44:48	*	*	*	*	*	*
5	6	37	M	4A	0	3	0	37:46	40:32	3	1	25	60	00:58	41:57	46:00	3	1	22	60	01:09
6	33	52	M	4A	0	4A	0	38:38	42:34	4A	1	45	90	01:18	43:03	*	*	*	*	*	*
7	1	45	M	4B	0	3	0	38:32	41:45	4A	1	32	90	00:30	44:25	45:06	4A	1	46	90	00:29
8	24	43	M	3	0	3	0	37:49	44:52	4A	1	60	150	02:34	47:42	48:18	4A	1	56	150	00:34
9	28	39	M	4B	0	4B	0	37:18	45:15	4B	2	48	150	01:20	46:51	48:14	4B	1	56	150	01:02
10	11	39	M	3	0	3	0	30:00	30:47	4B	2	23	60	00:47	32:20	32:45	4B	2	38	60	00:40
11	5	33	F	4B	0	2	0	43:00	45:25	4B	2	55	135	02:45	48:30	51:00	4B	2	38	60	00:51
12	32	64	M	4A	0	3	0	34:10	40:52	4A	1	30	150	01:21	42:24	44:15	4A	1	79	150	01:00
13	18	44	M	3	0	2	0	39:24	50:40	3	1	92	210	01:40	54:10	54:58	3	1	94	210	00:33
14		45	M	4A	0	4A	0	36:25	40:41	4A	1	50	120	01:03	42:03	42:46	4A	1	41	120	00:30
15		39	F	3	0	3	0	32:58	33:40	4A	1	31	60	00:50	35:00	36:00	4A	1	28	60	00:49

Subject number from prior study, Ljubkovic et al. (18), is shown in Table 2, under same dive profile. Times are in min:s. BS, bubble score; F, female; art, arterialization; ex, exercise. *Subjects did not display arterialization during the second bout of exercise. †Initial BS is of subjects at rest during previous study (18). ‡Time to clear is time when arterialization of gas bubbles was no longer observed breathing room air. §Time to clear with O₂ is time when arterialization of gas bubbles was no longer observed breathing oxygen.

Table 4. Subjects who did not arterialize during rest or exercise

Subject No.	Subject No. Prior Study	Age, yr	Sex	Initial Bubble Score Cardiac Chamber		Upright Bubble Score Cardiac Chamber		Time of Ex Onset, min:s	Peak BS During Ex
				R	L	R	L		
16	27	41	M	2	0	1	0	38:50	1
17	3	46	M	3	0	2	0	32:55	3
18	34	30	M	1	0	0	0	36:06	1
19	13	30	M	0	0	0	0	34:00	1
20	19	24	M	0	0	0	0	42:53	0
21		50	M	1	0	0	0	37:41	0
22		29	M	1	0	0	0	33:20	0
23		43	F	0	0	0	0	32:10	0

Subject number from prior study, Ljubkovic et al. (18), is shown in Table 2.

no change in VGE (2 min $P = 0.634$, 6 min $P = 0.567$). The reduction was not significant until 16 min into the protocol ($P = 0.026$). Additional details are displayed in Table 5.

Determinants of arterialization. There was no difference in the time to starting exercise in the group that arterialized (subjects 4–15) and the group that did not (subjects 16–23) ($P = 0.58$). However, in subjects who arterialized with exercise, both the supine and upright resting bubble scores were significantly higher than in the subjects who did not exhibit exercise arterialization ($P = 0.001$ and 0.0009 for supine and upright position, respectively) There was a significant difference in the time for arterialization to stop after exercise when oxygen was used ($P = 0.035$).

DISCUSSION

The purpose of this study was to investigate the possibility that exercise may increase the incidence of arterial gas embolism after SCUBA diving, presumably via opening of IPAVA. Our results show that 12 subjects who were not arterializing at rest after SCUBA diving experienced arterialization during exercise on a cycle ergometer. Although the subjects were seated in an upright position during exercise, it is unlikely that the posture change alone was responsible for arterialization, since subjects were observed in both the seated and supine positions at rest. A recent study by Ljubkovic et al. (18) has detailed the conditions necessary to provoke arterialization of

VGE after diving at rest. One of these conditions was a bubble score of at least 4B in the right heart. We have shown that, with postdive exercise, divers can arterialize with a bubble score as low as 3. For subjects 16–23, who we did not observe any arterialization, bubble score during exercise at $\dot{V}O_{2max}$ ranged from 0 to 3. It is possible that the IPAVA were open, providing a potential path to arterialization, yet there was a lack of adequate or even any observable VGE to pass through them. Of these eight subjects who did not arterialize, only one produced a bubble score of 3, while the rest produced peak scores of 0 or 1 throughout the duration of the study.

In subjects who were exposed to the exercise protocol, the timing of exercise after diving may impact arterialization, since divers typically reach peak bubble production 30–60 min after surfacing. It is thus possible that timing of exercise could be the difference between arterialization or not. However, in this study, there was no significant difference in the exercise start time between those who did and those who did not arterialize (subjects 4–15 and 16–23). Rather, there was a significant difference in the initial bubble score, both supine and seated, which may contribute to arterialization during exercise. It is possible that there is still a minimal bubble score required to arterialize, even if open IPAVA during exercise provide a pathway. For the subjects who arterialized at rest (subjects 1–3), two of them fit the requirements for arterialization at rest, as described before (18), while one was just below the threshold. It is possible that IPAVA could be the pathway if the activity between surfacing and arriving to the testing site was enough to open them, or it may be that the higher bubble score was enough on its own to overwhelm the pulmonary clearing capacity.

It has been proposed by Eldridge et al. (9) that exercise opens up normally closed arteriovenous intrapulmonary shunts

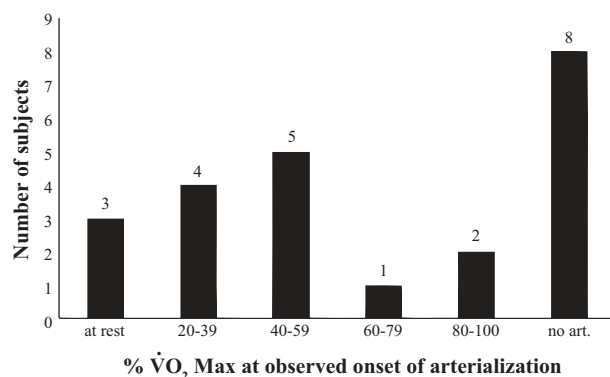

Fig. 1. Percentage of maximum O_2 uptake ($\dot{V}O_{2max}$) during observed arterializations. Histograms represent the distribution of intensity, as a percentage of $\dot{V}O_{2max}$ at which arterialization was observed during exercise. art., Arterialization.

Table 5. Bubble score of all subjects during oxygen subgroup

Subject No.	Bubble Score at Various Time Points, min					
	0	2	6	10	16	20
15	3	3	3	3	2	2
4	3	2	3	2	3	3
8	3	3	4	3	1	1
10	3	3	3	3	2	2
13	4	4	4	3	3	2
11	3	3	3	3	2	2
<i>P</i> value	n/a	0.634	0.567	0.248	0.026	0.009

in healthy humans. In their study, with incremental cycle ergometer exercise, 21 out of 23 PFO negative subjects demonstrated the passage of contrast bubbles from the right to left heart, as viewed in a four-chamber echocardiogram. This occurrence of shunting was again demonstrated by Lovering et al. (20, 21) and Stickland et al. (24) when eight of nine, seven of seven, and seven of eight subjects, respectively, shunted during exercise. Although Dujic et al. (7) reported previously that shunting did not occur with exercise after diving, in a case study presented by that same group in 2007 (22), in the current experimental setting, divers displayed a high level of VGE and shunting with exercise following a dive. There are at least four possible explanations for the discrepancies between our present findings and previous studies. 1) We continuously monitored the subjects rather than only during select time points, so it is less likely that arterialization could have occurred during a period of time that we were not monitoring. 2) This study has a higher number of subjects than previous studies with divers. 3) As imaging technology improves, the investigators have decreased chances to miss the passage of emboli due to a lack of resolution. 4) The subjects in this study exercised until voluntary termination rather than toward a predetermined HR or workload, so it is unlikely that those who did not arterialize failed to do so as a result of not exercising at a high enough intensity.

Asymptomatic venous bubbles are common after a dive and vary in size from 19 to 700 μm (12). The diameter of capillaries at the site of gas exchange ranges from 6 to 15 μm and does not allow easy passage of these bubbles from the venous to the arterial circulation. The trapped bubbles are commonly eliminated during gas exchange and ventilation. However, this system of clearing bubbles from the blood may be overwhelmed by a high bubble load in the circulation, greater than the pulmonary circuit is capable of clearing, allowing VGE to cross over to the arterial circulation, either through IPAVA, through distention of pulmonary capillaries, or through deformation of bubbles into cylindrical shapes (1). Under the theoretical, ideal conditions, larger bubbles may deform into a cylindrical shape to pass through smaller diameter vessels (3). Alternatively, as bubbles outpace the pulmonary circuit's ability to eliminate them through gas exchange, pulmonary arterial pressure may increase as a result of the stack of bubbles blocking local circulation (6, 17). This increase in pulmonary arterial pressure may then open the IPAVA and allow bubbles to pass, as previously suggested by Stickland et al. (24). In our laboratory's previous studies, it has been shown that a bubble score of 4B is likely a prerequisite for arterialization at rest (18). These studies excluded divers with PFO, so VGE may not cross over through defects in the septal wall. This may explain why during PFO testing, when large quantities of bubbles are injected in subjects who are found to be PFO negative, bubbles appear in the left heart in lower quantities after 10 or more cardiac cycles.

In this study, administration of oxygen upon detection of gas bubbles in the left heart, both resting and immediately after exercise, caused rapid cessation of arterialization in all tested individuals. Furthermore, the use of oxygen terminated arterialization quite rapidly compared with breathing room air. We hypothesize that this is related to the mechanism of closing IPAVA with the application of oxygen. One alternative to this proposal is that a decrease in arterialization is related to an

increased rate of nitrogen elimination, seen as a reduction of bubble load in the right heart. Oxygen prebreathing is used in high-altitude flights and astronaut extravehicular activity to eliminate nitrogen from the blood via an increased concentration gradient, and this principle has also been applied to SCUBA diving (2). This denucleation protocol can last between 1 and 4 h for high-altitude excursions (30). Exercise can speed this process up by increasing cardiac output and blood flow through the pulmonary circuit, although even the shortened protocols studied last at least 15 min (29). Due to the rapid cessation of arterialization (46 s mean) and the relatively low duration of oxygen administration, the time frame matches up more closely with other exercise and IPAVA studies rather than nitrogen washout. Additionally, our subgroup of six divers breathing oxygen shows that, while oxygen did reduce VGE in divers at rest, this reduction was not significant until 16 min into the administration procedure. However, we cannot completely rule out the possibility that breathing 100% O_2 , leading to an increased gradient for nitrogen elimination at the alveolocapillary membrane, may still reduce the amount of bubbles in the pulmonary microcirculation.

To our knowledge, this is the first study that demonstrates the use of supplemental O_2 can stop arterialization after SCUBA diving. The use of oxygen significantly decreased the time for arterialization to stop, compared with breathing room air, in exercise (*subjects 4–15*, $P = 0.035$). With only three subjects arterializing at rest, statistical conclusions are of little use; however, in this study, the difference in the time to stop arterializing with oxygen vs. room air is noticeable. In the case of both rest and exercise, once the subject was taken off the oxygen, arterialization resumed after a relatively short amount of time. Without the use of supplemental oxygen, the half-life of the bubble scores and arterialization at rest followed closely with previously observed results with similar dive profiles (25). The mean time for the reduction of the bubble score to zero in the left heart occurred at 45:05 min after surfacing, accompanied by a concurrent decrease in VGE in the right cardiac chambers. For the subjects who shunted with exercise, while oxygen did decrease the time to clear emboli from the left heart, for practical purposes, removing the exercise stimulus also stopped arterialization within a few minutes.

Study limitations. There are other possible explanations for VGE to appear in the left heart other than IPAVA. Bubbles will decrease in diameter as time passes and may become small enough to pass through the pulmonary microcirculation, although bubbles of this size would be much more difficult to visualize via TTE and less likely to survive until they reach the left side of the heart. Larger gas emboli may also deform into a cylindrical shape with a small enough diameters to pass through the pulmonary circulation to be visualized in the left heart. Regardless of these limitations, 65% of divers arterialized (exercise and rest) in the postdive period of our study. This proportion is much greater than is found in studies that examine these parameters for divers at rest, which range between 0 and 39% (16, 18). Another study by Gerriets et al. (11) observed arterialization in 7 of 13 dives where VGE were present; however, five of these incidences were associated with PFO. One of the primary drawbacks to using VGE resulting from decompression as a visualization agent is the relatively small load compared with a bolus injection. For optimal echo

imaging conditions, exercise was initiated 30–40 min after surfacing, so that observations would be made during the postdive time period in which divers tend to produce their peak bubble scores (5). It is possible that subjects could have arterialized with or without this exercise, even if they were not during the initial 30-min TTE evaluation. However, three subjects arterialized with a bubble score of 3, and six subjects with a score of 4A. These are lower scores than typical arterializations at rest.

Conclusions. The safety of exercise after diving has been debated for some time. We have shown that exercise may directly contribute to arterialization. It may be concluded that exercise directly increases vulnerability to arterialization of VGE after diving. In some individuals, specifically those who have a low workload threshold for opening of IPAVA, it is possible that even relatively mild physical exertion associated with surface swimming at the end of a dive, climbing onto a boat, or walking with heavy gear on would be enough to provoke arterialization. These could all be considered regular activities that occur within 0 to 90 min after surfacing. This study also demonstrates the possibility that divers without PFO under certain circumstances may arterialize much more than it was previously thought. Divers who shunt at rest or at very low levels of exercise may be at similar risk levels as those with PFO. Conservative diving has been shown to decrease the risk of DCS in divers with a PFO (14), a similar tactic may be useful for individuals with VGE at low exercise intensities. Although many studies have shown that divers can arterialize with no DCS symptoms, there still remains a correlation between neurological DCS and the presence of arterial bubbles. Finally, subclinical levels of damage related to microemboli in the brain should not be ignored, especially in career divers.

ACKNOWLEDGMENTS

The authors thank the volunteer divers for participation in this study, and Diving Club Nautilus and Robert Kramaric for organization of the field diving activities. We also thank Dr. Mihajlo Loipur, Ivana Banic, and Dr. Vladimir Ivancev for knowledge, professionalism, and expertise.

GRANTS

This work was supported by FP7-PEOPLE-2010-ITN (264816 PHYPODE) and Croatian Ministry of Science, Education and Sports (Grant No. 216-2160133-0130 to Z. Dujic).

DISCLOSURES

No conflicts of interest, financial or otherwise, are declared by the author(s).

AUTHOR CONTRIBUTIONS

Author contributions: D.M., M. Lozo, Z.D., and M. Ljubkovic conception and design of research; D.M. and M. Lozo performed experiments; D.M., M. Lozo, Z.D., and M. Ljubkovic analyzed data; D.M., M. Lozo, Z.D., and M. Ljubkovic interpreted results of experiments; D.M. prepared figures; D.M. drafted manuscript; D.M., M. Lozo, Z.D., and M. Ljubkovic edited and revised manuscript; Z.D. and M. Ljubkovic approved final version of manuscript.

REFERENCES

- Barak M, Katz Y. Microbubbles: pathophysiology and clinical implications. *Chest* 128: 2918–2932, 2005.
- Bosco G, Yang ZJ, Di Tano G, Camporesi EM, Faralli F, Savini F, Landolfi A, Doria C, Fano G. Effect of in-water oxygen prebreathing at different depths on decompression-induced bubble formation and platelet activation. *J Appl Physiol* 108: 1077–1083, 2010.
- Branger AB, Eckmann DM. Theoretical and experimental intravascular gas embolism absorption dynamics. *J Appl Physiol* 87: 1287–1295, 1999.
- Butler BD, Hills BA. Transpulmonary passage of venous air emboli. *J Appl Physiol* 59: 543–547, 1985.
- Dujic Z, Duplancic D, Marinovic-Terzic I, Bakovic D, Ivancev V, Valic Z, Eterovic D, Petri NM, Wisloff U, Brubakk AO. Aerobic exercise before diving reduces venous gas bubble formation in humans. *J Physiol* 555: 637–642, 2004.
- Dujic Z, Obad A, Palada I, Valic Z, Brubakk AO. A single open sea air dive increases pulmonary artery pressure and reduces right ventricular function in professional divers. *Eur J Appl Physiol* 97: 478–485, 2006.
- Dujic Z, Palada I, Obad A, Duplancic D, Brubakk AO, Valic Z. Exercise-induced intrapulmonary shunting of venous gas emboli does not occur after open-sea diving. *J Appl Physiol* 99: 944–949, 2005.
- Eftedal O, Brubakk AO. Agreement between trained and untrained observers in grading intravascular bubble signals in ultrasonic images. *Undersea Hyperb Med* 24: 293–299, 1997.
- Eldridge MW, Dempsey JA, Haverkamp HC, Lovering AT, Hokanson JS. Exercise-induced intrapulmonary arteriovenous shunting in healthy humans. *J Appl Physiol* 97: 797–805, 2004.
- Gao GK, Wu D, Yang Y, Yu T, Xue J, Wang X, Jiang YP. Cerebral magnetic resonance imaging of compressed air divers in diving accidents. *Undersea Hyperb Med* 36: 33–41, 2009.
- Gerriets T, Tetzlaff K, Liceni T, Schafer C, Rosengarten B, Kopiske G, Algermissen C, Struck N, Kaps M. Arteriovenous bubbles following cold water sport dives: relation to right-to-left shunting. *Neurology* 55: 1741–1743, 2000.
- Hills BA, Butler BD. Size distribution of intravascular air emboli produced by decompression. *Undersea Biomed Res* 8: 163–170, 1981.
- Kennedy JM, Foster GE, Koehle MS, Potts JE, Sandor GG, Potts MT, Houghton KM, Henderson WR, Sheel AW. Exercise-induced intrapulmonary arteriovenous shunt in healthy women. *Respir Physiol Neurobiol* 181: 8–13, 2012.
- Klingmann C, Rathmann N, Hausmann D, Bruckner T, Kern R. Lower risk of decompression sickness after recommendation of conservative decompression practices in divers with and without vascular right-to-left shunt. *Diving Hyperb Med* 42: 146–150, 2012.
- Knauth M, Ries S, Pohmann S, Kerby T, Forsting M, Daffertshofer M, Hennerici M, Sartor K. Cohort study of multiple brain lesions in sport divers: role of a patent foramen ovale. *BMJ* 314: 701–705, 1997.
- Ljubkovic M, Dujic Z, Mollerlokken A, Bakovic D, Obad A, Breskovic T, Brubakk AO. Venous and arterial bubbles at rest after no-decompression air dives. *Med Sci Sports Exerc* 43: 990–995, 2011.
- Ljubkovic M, Marinovic J, Obad A, Breskovic T, Gaustad SE, Dujic Z. High incidence of venous and arterial gas emboli at rest after trimix diving without protocol violations. *J Appl Physiol* 109: 1670–1674, 2010.
- Ljubkovic M, Zanchi J, Breskovic T, Marinovic J, Lojpur M, Dujic Z. Determinants of arterial gas embolism after scuba diving. *J Appl Physiol* 112: 91–95, 2012.
- Longphre JM, Denoble PJ, Moon RE, Vann RD, Freiburger JJ. First aid normobaric oxygen for the treatment of recreational diving injuries. *Undersea Hyperb Med* 34: 43–49, 2007.
- Lovering AT, Romer LM, Haverkamp HC, Pegelow DF, Hokanson JS, Eldridge MW. Intrapulmonary shunting and pulmonary gas exchange during normoxic and hypoxic exercise in healthy humans. *J Appl Physiol* 104: 1418–1425, 2008.
- Lovering AT, Stickland MK, Amann M, Murphy JC, O'Brien MJ, Hokanson JS, Eldridge MW. Hyperoxia prevents exercise-induced intrapulmonary arteriovenous shunt in healthy humans. *J Physiol* 586: 4559–4565, 2008.
- Obad A, Palada I, Ivancev V, Valic Z, Fabijanic D, Brubakk AO, Dujic Z. Sonographic detection of intrapulmonary shunting of venous gas bubbles during exercise after diving in a professional diver. *J Clin Ultrasound* 35: 473–476, 2007.
- Ries S, Knauth M, Kern R, Klingmann C, Daffertshofer M, Sartor K, Hennerici M. Arterial gas embolism after decompression: correlation with right-to-left shunting. *Neurology* 52: 401–404, 1999.
- Stickland MK, Welsh RC, Haykowsky MJ, Petersen SR, Anderson WD, Taylor DA, Bouffard M, Jones RL. Intra-pulmonary shunt and pulmonary gas exchange during exercise in humans. *J Physiol* 561: 321–329, 2004.

25. **Thom SR, Milovanova TN, Bogush M, Bhopale VM, Yang M, Bushmann K, Pollock NW, Ljubkovic M, Denoble P, Dujic Z.** Microparticle production, neutrophil activation, and intravascular bubbles following open-water SCUBA diving. *J Appl Physiol* 112: 1268–1278, 2012.
26. **Torti SR, Billinger M, Schwerzmann M, Vogel R, Zbinden R, Windecker S, Seiler C.** Risk of decompression illness among 230 divers in relation to the presence and size of patent foramen ovale. *Eur Heart J* 25: 1014–1020, 2004.
27. **Vann RD, Butler FK, Mitchell SJ, Moon RE.** Decompression illness. *Lancet* 377: 153–164, 2011.
28. **Warren LP Jr, Djang WT, Moon RE, Camporesi EM, Sallee DS, Anthony DC, Massey EW, Burger PC, Heinz ER.** Neuroimaging of scuba diving injuries to the CNS. *AJR Am J Roentgenol* 151: 1003–1008, 1988.
29. **Webb JT, Fischer MD, Heaps CL, Pilmanis AA.** Exercise-enhanced preoxygenation increases protection from decompression sickness. *Aviat Space Environ Med* 67: 618–624, 1996.
30. **Webb JT, Pilmanis AA.** Preoxygenation time versus decompression sickness incidence. *SAFE J* 29: 75–78, 1999.

